

TangenX[®] SIUS[®] Gamma TFF Device

Regulatory Support File



The information contained in this document is subject to change without notice.

With respect to documentation accompanying Product Repligen makes no warranty, express or implied. Any and all warranties related to the documentation accompanying Product are expressly disclaimed. Customer shall refer to the terms and conditions of sale governing the transaction for any and all warranties for the Product.

Repligen Corporation shall not be liable for errors contained herein or for incidental or consequential damages in connection with the furnishing, performance, or use of this material.

No part of this document may be photocopied, reproduced, or translated to another language without the prior written consent of Repligen Corporation.

Products are not intended for diagnostic or therapeutic use or for use in vivo with humans or animals.

For further information, please contact Repligen Corporation at www.repligen.com.

©2021 Repligen Corporation. All rights reserved. The trademarks mentioned herein are the property of Repligen Corporation and/or its affiliate(s) or their respective owners.

Customer Support

customerserviceUS@repligen.com

781-250-0111

Repligen Corporation

111 Locke Drive

Marlborough, Massachusetts 01752

www.repligen.com

Contents

1. Introduction	8
1.1 Repligen Quality Policy	8
1.2 Safety notices	8
1.3 Responsible official	8
1.4 Product description	8
1.5 Quality standards	10
2. Product information	10
2.1 Cassette design	10
2.2 Materials of construction	10
2.3 Product Contents	11
3. Important information before you begin	11
3.1 Devices and holders	11
3.1.1 Connectors	12
3.1.2 Pump	12
3.1.3 Preparation for use	12
3.2 TangenX® SIUS® Gamma TFF Device unpacking and installation	12
3.3 Preparation (water flush) of TangenX® SIUS® Gamma TFF Devices	13
3.4 Equilibration of TangenX® SIUS® Gamma TFF Devices	13
3.5 Disposal of used TangenX® SIUS® Gamma TFF Devices	13
3.6 Storage of unused TangenX® SIUS® Gamma TFF Devices	13
3.7 Membrane operating characteristics	13
3.8 Catalog and serial numbering system	13
3.9 Device batch numbers	14
4. Product performance	15
4.1 Membrane performance	15
4.2 Non-specific protein binding	16
4.3 Cassette hydraulic performance	17
4.4 Cassette integrity	20
4.5 Cassette pre-flushing	21
4.5.1 Purified water flush	21
4.5.2 Buffer equilibration	22
4.6 Robustness study	23
4.7 Shelf life study	24
4.7.1 Membranes	24
4.7.2 Conclusions	25
4.7.3 TangenX® SIUS® Gamma TFF Devices	25
4.7.4 Results	26
4.7.5 Conclusions	27
4.8 Chemical compatibility	28
5. Safety information	30
5.1 USP Class VI	30
5.2 Cassette leachables and extractables (L and E) following BPOG	32
5.3 Acceptance criteria	38
5.4 Endotoxin Test	38
5.5 Sterility	40
5.6 BSE free materials	42
5.7 Residual solvents	42
6. Qualification	43
6.1 Installation Qualification (IQ)	43
6.2 Operation Qualification (OQ)	43
6.3 Responsibilities	44
7. Manufacturing process validation	45
7.1 Membrane process validation	45

7.2	TangenX® SIUS® Gamma TFF Device process validation	47
8.	Release testing	48
8.1	Analytical method validation	48
8.2	Membrane QC method validation.....	48
8.3	Cassette QC method validation.....	49
8.4	Release specifications	49
8.5	Certificate of conformance	52
9.	List of TangenX® Cassette and Device studies	53
10.	References	53
	Index.....	54

List of tables

Table 1. Materials of construction.....	10
Table 2. Device specifications.....	11
Table 3. Recommended torque values.....	12
Table 4. Device serial number	13
Table 5. Catalog part number system.....	14
Table 6. Non-specific protein binding test results.....	17
Table 7. Recommended crossflow rates.....	18
Table 8. Typical NWP range for TangenX® SIUS® Cassettes	20
Table 9. Cassette integrity test results	21
Table 10. Cassette integrity specifications	21
Table 11. Normalized device flush volumes	22
Table 12. Buffer equilibration volumes	23
Table 13. Robustness testing.....	24
Table 14. Membrane acceptance test results: Ambient temperature	25
Table 15. Membrane acceptance test results: Elevated temperature (50°C)	25
Table 16. TangenX® SIUS® Cassette acceptance criteria	26
Table 17. Device acceptance test results: Elevated temperature (50°C)	27
Table 18. Device acceptance test results: Ambient temperature	27
Table 19. ProStream and HyStream membrane chemical compatibility.....	28
Table 20. TOC results summary	34
Table 21. pH results summary	34
Table 22. Non-volatile residue results summary	34
Table 23. TOC results for 30-minute sample extracts	35
Table 24. TOC results for 1-day sample extracts	35
Table 25. TOC results for 21-day sample extracts	35
Table 26. TOC system suitability results	36
Table 27. pH results for 30-minute sample extracts	36
Table 28. pH results for 1-day sample extracts	37
Table 29. pH results for 21-day sample extracts	37
Table 30. NVR results for 30-minute sample extracts	37
Table 31. NVR results for 1-day sample extracts.....	38
Table 32. NVR results for 21-day sample extracts.....	38
Table 33. Acceptance criteria	39
Table 34. Results of bioburden and endotoxin count study.....	39
Table 35. Bacteriostasis/Fungistasis (B/F)	41
Table 36. Recovery Efficiency (RE).....	41
Table 37. Bioburden Determination Summary.....	41
Table 38. Test of Sterility Summary.....	41
Table 39. Results of residual solvents: HPLC-MS.....	43
Table 40. Device validation: Data summary	48

List of figures

Figure 1. TangenX® SIUS® Gamma PD TFF Device	9
Figure 2. TangenX® SIUS® Gamma TFF Device	9
Figure 3. Serial number example.....	14
Figure 4. Catalog part number system	15
Figure 5. Membrane performance: MWCO vs. NWP	16
Figure 6. Membrane performance: MW vs. % rejection	16
Figure 7. Cross flow flux at 10 psi D.P. for TangenX® SIUS® PD.....	18
Figure 8. NWP for 30 kD TangenX® SIUS® and TangenX® SIUS® Gamma TFF Devices	19
Figure 9. TangenX® SIUS® Gamma TFF Device surface area vs. water flux	19
Figure 10. Membrane surface with pinhole (100x magnification)	20

Figure 11. Example device flush flow path	22
Figure 12. Example buffer equilibration flow path.....	22
Figure 13. Membrane acceptance criteria for shelf life results.....	25
Figure 14. USP testing results.....	30
Figure 15. Summary of USP testing results	31
Figure 16. General Procedure for Bacterial endotoxin test.....	39
Figure 17. References for Bacterial endotoxin test	39
Figure 18. Membrane validation: Data summary.....	46
Figure 19. Device QC release specifications	50
Figure 20. Membrane QC release specifications (10 kD - 300 kD)	51
Figure 21. QA Certificate of conformance for TangenX® SIUS® Gamma TFF Device	52

Abbreviations

AAMI	Association for the Advancement of Medical Instrumentation
BPOG	BioPhorum Operations Group
ccm	Cubic centimeter per minute
CF	Crossflow
CFU	Colony forming units
cGMP	Current Good Manufacturing Practice
DF	Diafiltration
DI	Deionized
DMAC	Dimethyl acetamide
D.P.	Pressure drop
D Vol	Diavolume
ea	Each
EDTA	Ethylenediaminetetraacetic acid
ERP	Enterprise Resource Planning
FDA	Food and Drug Administration
ft ²	Feet squared (square feet)
GMP	Good Manufacturing Practice
In	Inches
kD	Kilodalton
Kg	Kilogram
Lbs	Pounds
LMH	Liters per minute per square meters
LPB	Low protein binding
L/min	Liter per minute
LPM	Liter per minute
m ²	Meter squared (square meter)
ml	Milliliters
mPES	Modified polyethersulfone
MWCO	Molecular weight cut-off
N-m	Newton meter
NMP	N-methyl pyrrolidone
NVR	Non-volatile residue
NWP	Normalized water permeability
PD	Process development
Perm Vol	Permeate volume
psi	Pounds per square inch
psig	Pounds per square inch
QA	Quality assurance
QC	Quality control
QMS	Quality Management System
RSF	Regulatory Support File
TFF	Tangential flow filtration
TMP	Transmembrane pressure
UF	Ultrafiltration
WFI	Water for injection

1. Introduction

The Regulatory Support File (RSF) for TangenX® SIUS® Gamma TFF Devices is intended to be used as:

- A guide for appropriate application use in process development, clinical, and commercial purification processes.
- A guide to validation in manufacturing processes.
- A support reference for CMC submissions for regulatory license approval.
- A guide for supplier audits.
- An alternative to a Drug Master File submission.

Repligen is committed to providing all relevant technical, manufacturing, and quality information, however, only non-confidential information is presented in this document. Confidential details may be made available upon request through a formal confidentiality agreement or as part of a supplier audit.

1.1 Repligen Quality Policy

A copy of the Repligen quality policy can be found at <https://www.repligen.com/resources/quality>.

1.2 Safety notices

- Follow all local regulations for safe disposal
- For laboratory and manufacturing production only

1.3 Responsible official

The individual designated responsible for quality and regulatory affairs for Repligen, and to whom all correspondence or requests for audits should be addressed.

Senior Director of Quality
Telephone: +1-781.250.0111
Email: customerserviceUS@repligen.com

1.4 Product description

TangenX® SIUS® Gamma TFF Devices are single-use, gamma-irradiated tangential flow filtration (TFF) flat sheet cassettes used to concentrate biomolecules and exchange buffers through ultrafiltration and diafiltration processes. TangenX® SIUS® Gamma TFF Devices are a closed system composed of a TangenX® SIUS® Cassette adhered to a filter plate insert with flow path tubing sets that terminate with aseptic connectors. The complete device is gamma-irradiated for the purpose of bioburden reduction. TangenX® SIUS® Gamma TFF Devices and TangenX® SIUS® Cassettes are constructed using the same membranes and deliver equivalent performance. TangenX® SIUS® Gamma TFF Devices provide an irradiated, closed system for applications requiring an assembled TFF device that is aseptically isolated from the environment.

Figure 1. TangenX® SIUS® Gamma PD TFF Device

TangenX® SIUS® Gamma PD TFF Devices ([Figure 1](#)) for lab-scale and pilot applications are available with a membrane surface area of 0.1 m², a range of membrane pore sizes (10 kD, 30 kD, 50 kD, 100 kD, and 300 kD), two (2) membrane chemistries (ProStream and HyStream modified polyethersulfone (mPES)), and two (2) channel configurations (L-screen and E-screen). The L-screen is ideal for low to medium viscosity streams where high flux and lower recirculation rates are desired. The E-screen is ideal for medium to high viscosity streams while still maintaining a beneficial cross flow rate.

Figure 2. TangenX® SIUS® Gamma TFF Device

TangenX® SIUS® Gamma TFF Devices ([Figure 2](#)) for process applications are available with a membrane surface area of 0.5 m², 1.5 m², 2.5 m², 5 m², 10 m², a range of membrane pore sizes (10 kD, 30 kD, 50 kD, 100 kD, and 300 kD), two (2) membrane chemistries (ProStream and HyStream mPES), and two (2) channel configurations (L-screen and E-screen). TangenX® SIUS® Gamma TFF Devices are designed for processing volumes from 10s - 1000s of liters.

The TangenX® SIUS® Gamma TFF Devices represent the latest development in tangential flow filtration cassette design and performance. They are designed to deliver optimal performance as well as exceptional batch-to-batch reproducibility. Each device undergoes rigorous QA lot release testing to verify it meets specification. Devices are tested for both air integrity and hydrodynamic performance. This testing ensures consistency from device-to-device, scalable process development, and reproducible manufacturing.

1.5 Quality standards

In order to meet the needs of GMP manufacturing, TangenX® SIUS® Gamma TFF Devices are manufactured in the USA under the following quality standards:

- TangenX® SIUS® Gamma TFF Devices are manufactured in a facility whose Quality Management System is approved by an accredited registering body to the ISO® 9001 2015 Quality System Standard.
- TangenX® SIUS® Gamma TFF Devices are manufactured in a facility that adheres to current Good Manufacturing Practices.
- All fluid paths meet USP <88> Biological Reactivity Tests for Class VI Plastics criteria.

2. Product information

2.1 Cassette design

TangenX® SIUS® Gamma TFF Devices are designed and constructed using FDA approved materials that have been validated for use in demanding biopharmaceutical applications. Each device is manufactured according to a fully validated and documented manufacturing process that adheres to the principles of cGMP and meet specified release criteria. The TangenX® SIUS® Gamma PD laboratory-scale and TangenX® SIUS® Gamma process-scale TFF Devices are purpose-built for single-use processing in a closed system with optimal performance that is equivalent to the TangenX® SIUS® Cassette product line.

2.2 Materials of construction

TangenX® SIUS® Gamma PD and TangenX® SIUS® Gamma TFF Devices are constructed of FDA approved materials.

Table 1. Materials of construction

Component	Material
Membrane	Modified polyethersulfone (mPES)
Membrane support	Polypropylene (PP)
Channel configurations: L-screen (feed/retentate channel)	High density polyethylene (HDPE) medium woven PP screen
E-screen (feed/retentate channel)	High density polyethylene (HDPE) spacer with coarse woven PP screen
Filtrate channel (both L-screen and E-screen)	Polyurethane with medium woven PP screen
Encapsulant: Feed/retentate channel	Class VI approved silicone
Filtrate channel	Class VI approved polyurethane
Cassette gasket	Ethylene propylene diene monomer (EPDM)
Filter plate insert	Polypropylene
Braided tubing	Platinum cured silicon
Tri-clover clamp	Nylon glass filled
Tri-clover gasket	Platinum cured silicon
Hose-barb fitting	Polypropylene
AseptiQuik® fitting	Polycarbonate
Pinch clamp	Nylon glass filled

Table 2. Device specifications

Module characteristics	Surface area [‡]				
	0.1 m ²	0.5 m ²	1.5 m ²	2.5 m ²	5 m ²
Channel path length	16 cm				
Hold-up volume	61 mL	509 mL	874 mL	1026 mL	1470 mL
Working volume	0.2 L	1 L	3 L	5 L	10 L
Max temperature	40°C				
Max pressure (forward)	60 psi (4 bar)				
Max pressure (reverse)	7 psi (0.48 bar)				
Crossflow L-screen		2 - 4 L/min	6 - 12 L/min	10 - 20 L/min	20 - 40 L/min
Crossflow E-screen		3 - 6 L/min	9 - 18 L/min	15 - 30 L/min	30 - 60 L/min
ΔP L-screen	10 psi (0.7 bar)				
ΔP E-screen	5 psi (0.35 bar)				
Air integrity test pressure	7.3 psi (0.5 bar)				
Max air diffusion rate	323 ccm/m ²				
AseptiQuik® connector	G (genderless)				
Torque range	120-180 in-lbs (14 - 20 N-m)	300-450 in-lbs (33.9 - 50 N-m)			

[‡] The 10 m² TangenX® SIUS® Gamma TFF Device is a kit that consists of two cassettes, each 5 m² in size, joined in parallel using “Y” connectors.

2.3 Product Contents

TangenX® SIUS® Gamma PD TFF Device contents:

- One (1) TangenX® SIUS® Gamma PD TFF Device (cassette surface area, 0.1 m²)
- Certificate of Conformance
- Safety Data Sheet, 0.2 M sodium hydroxide
- Set-up Guide

TangenX® SIUS® Gamma TFF Device contents:

- For cassette surface area 0.5 m², 1.5 m², 2.5 m², or 5 m²:
 - One (1) TangenX® SIUS® Gamma TFF Device
- For cassette surface area 10 m²:
 - Two (2) TangenX® SIUS® Gamma TFF Devices (5 m²)
 - One (1) connecting tube set
 - One (1) Isolation plate
- Certificate of Conformance
- Safety Data Sheet, 0.2 M sodium hydroxide
- Set-up Guide

3. Important information before you begin

3.1 Devices and holders

TangenX® SIUS® Gamma TFF Devices are compatible with all TangenX® Cassette Holders.

- TangenX® SIUS® Gamma PD TFF Devices require TangenX® SIUS® PD 2-Bolt Manual Clamp (TSLDI-2BMC) holder (or equivalent).

- TangenX® SIUS® Gamma TFF Devices with surface area 0.5 m² – 5 m² require TangenX® SIUS® 4-Bolt Manual Clamp (TSPDI-4BMC) holder (or equivalent).
- TangenX® SIUS® Gamma TFF Devices with surface area 10 m² require 2-Bolt Vertical Auto-Torque system (TSPDI-V2AC).

Refer to the Set-up Guide or User Guide for instructions on how to clamp the cassette assemblies in the holder and for proper torque requirements.

3.1.1 Connectors

AseptiQuik® G aseptic connectors from CPC (or equivalent) are used on the feed, retentate, and permeate ports of the device for all products up to 5m². The 10m² device comes with a tube set with AseptiQuik® L aseptic connectors (or equivalent). Refer to the Set-up Guide or User Guide for information on how to connect the TangenX® SIUS® Gamma TFF Device in your system.

3.1.2 Pump

When using a TangenX® SIUS® Gamma TFF Device, select a pump with adequate capacity. Crossflow rate ranges are feed channel type and process fluid dependent. Refer to the Set-up Guide or User Guide.

3.1.3 Preparation for use

TangenX® SIUS® Gamma TFF Devices must be flushed with water and equilibrated with an appropriate buffer (i.e., phosphate buffered saline) to ensure the neutralization of the 0.2 M sodium hydroxide storage agent in the membrane filter. It is important to use pre-filtered buffer to avoid fouling the membrane or introducing contaminants into the system that could affect membrane performance and product recovery. Refer to the Set-up Guide or User Guide for additional information.

3.2 TangenX® SIUS® Gamma TFF Device unpacking and installation

Refer to the Set-up Guide or User Guide for unpacking and installation instructions.

Warning: Each cassette is stored in a 0.2 M sodium hydroxide solution as a preservative. Follow standard safety procedures for handling a 0.2 M sodium hydroxide solution, including the use of gloves, safety goggles, and lab coat.

The cassette must be installed in the holder properly to avoid damaging the cassette and to avoid leaks. Refer to the Set-up Guide or User Guide for proper installation and torque sequence. The recommended torque values are also listed below. Use a calibrated torque wrench.

Table 3. Recommended torque values

Holder type	Recommended torque range	
	Inch – lbs	N - m
TangenX® SIUS® Gamma PD Holder	120 - 180	14 - 20
TangenX® SIUS® Gamma Holder	300 - 450	35 – 50
Holder Type	Hydraulic Pressure	
	PSI	N/m ²
TangenX® SIUS® Auto-Torque	1,100-1,300	70-100

3.3 Preparation (water flush) of TangenX® SIUS® Gamma TFF Devices

Devices can be flushed with water (5 L/m² through the retentate and 10 L/m² through the permeate) to displace the 0.2 M sodium hydroxide storage agent prior to equilibration.

3.4 Equilibration of TangenX® SIUS® Gamma TFF Devices

Devices must be equilibrated with an appropriate buffer (e.g., phosphate buffered saline) to ensure the neutralization of the 0.2 M sodium hydroxide storage agent in the membrane filter. Verify the pH of the effluent from the cassette is neutralized to minimize any possible interaction with your application. For most applications, further sanitization is not required.

3.5 Disposal of used TangenX® SIUS® Gamma TFF Devices

TangenX® SIUS® Gamma TFF Devices are removed from the holder by reversing the device installation procedure. Devices can then be disposed of in a biohazard container. Disposal will be dependent on the feed stream used and the user's facility requirements.

3.6 Storage of unused TangenX® SIUS® Gamma TFF Devices

Membrane cassettes must remain sealed in their original packaging prior to use to maintain their characteristics and integrity, and to prevent microbial growth. Below are critical factors to remember when storing unused TangenX® SIUS® Gamma TFF Devices.

Recommended storage temperature:

- 15°C - 25°C (optimal)
- 40°C (maximum)
- Do not freeze devices

3.7 Membrane operating characteristics

Take care to use the membrane at the lowest pressure possible while still producing consistent permeate flow. Although higher operating pressures initially improve flow rate, it also promotes increased concentration polarization and membrane compaction, which ultimately limits flow.

3.8 Catalog and serial numbering system

Table 4. Device serial number

Decade code:	
2000 - 2009	1
2010 - 2019	2
2020 - 2029	3
Year code:	
1-digit (last digit of current year)	0 - 9
Julian day:	
3-digit	001 - 366
Sequential number (of the cassette within the cassette batch):	
3-digit	001 - 999

Figure 3. Serial number example

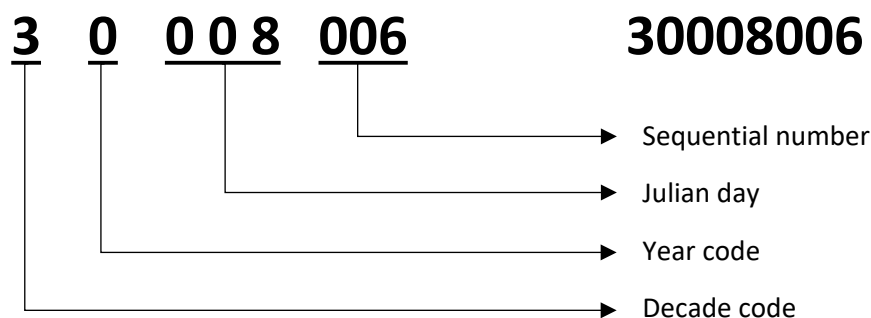

3.9 Device batch numbers

Cassette batch numbers are printed on each cassette label. The batch number is the eight (8) digit manufacturing process order number assigned by the ERP system. A “batch” is defined as a group of consecutively serialized cassettes manufactured on the same day, built from up to 6 different raw material lots and generated from the same ERP process order. Batch traceability is maintained on the batch record and in the ERP system.

Table 5. Catalog part number system

Membrane type:			
ProStream	mPES	Low protein binding (LPB)	P
HyStream	mPES	Ultra-hydrophilic and LPB	X
Substrate type:			
Polypropylene			P
Membrane cut-off:			
10 kD			010
30 kD			030
50 kD			050
100 kD			100
300 kD			300
Configuration code:			
TangenX® SIUS® Gamma PD		Single use (lab/pilot)	C
TangenX® SIUS® Gamma		Single use (process)	F
Membrane area:			
0.1 m ²	(1.1 ft ²)	Available: C	01
0.5 m ²	(5.4 ft ²)	Available: F	05
1.5 m ²	(16.2 ft ²)	Available: F	15
2.5 m ²	(26.9 ft ²)	Available: F	25
5 m ²	(53.8 ft ²)	Available: F	50
10 m ²	(107 ft ²)	Available: F	99
Channel type:			
L-screen		Medium woven	L
E-screen		Coarse woven	E

Figure 4. Catalog part number system

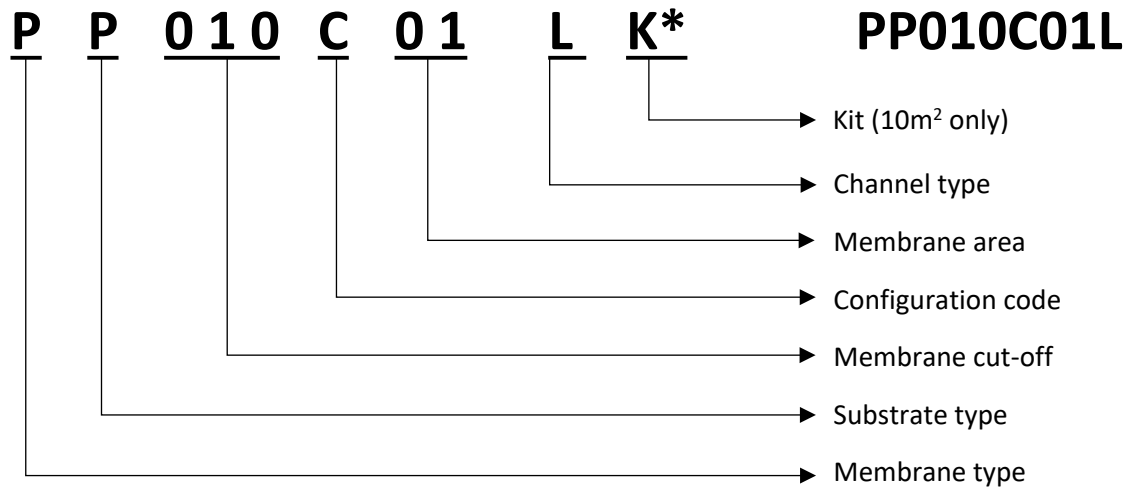

- K is only used for 10m² products – Leave blank for all other products

4. Product performance

4.1 Membrane performance

Designed for use in a wide range of biopharmaceutical applications, especially those that are protein based, TangenX® ProStream and HyStream membranes manufactured by Repligen represent the latest in development of modified polyethersulfone (mPES). In contrast to conventional composite mPES ultrafiltration (UF) membranes that are made in multi-step manufacturing processes and often include a post-casting surface modification, TangenX® mPES membranes have been developed from state-of-the-art technology including two unique features that deliver significant user benefits:

Single-cast, uniquely controllable manufacturing process:

- Balanced flux and selectivity are the result of this highly controllable manufacturing process that enables tight control of the macro-porous/UF transition interface. The macro-porous and UF “zones” of this membrane are a finely controlled continuum. This controlled transition ensures negligible breakthrough of the UF skin maximizing selectivity performance.
- A reduced numbers of manufacturing steps delivers excellent consistency and reliability at a lower cost.

Integral cast modification of the membrane chemistry:

- The addition of a second polymer into the pre-casting membrane solution ensures total and consistent surface modification that delivers very low protein binding due to the membranes neutral charge and excellent chemical resistance.

The result, an application-focused membrane with a finely balanced performance profile that combines:

- The flux of a highly porous UF membrane substructure with the retention and selectivity of a composite structure.
- Highly desirable low protein binding properties that maximize recovery and have comparable chemical resistance to unmodified polymeric membranes.

Water flux data was generated using membrane cut to 44.5 mm discs in stirred cells at 50 psig and purified water at 20°C. At typical working conditions in stirred cells (50 psig), purified water was

used to measure the membrane's water permeability. TangenX® ProStream and HyStream mPES membranes demonstrate comparable water permeability.

Many membranes are formulated for either retention or flux. TangenX® mPES membranes have been designed to be balanced across both. [Figures 5](#) and [6](#) show the retention and rejection data for each membrane in the molecular weight cutoff (MWCO) series. When reviewed in conjunction with the MWCO series normalized water permeability (NWP) data in [Figure 5](#), the user can specifically select a membrane that best balances flux and retention for their specific application.

Under specified test conditions using stirred cells, purified proteins and molecular weight markers were used to challenge the membranes. TangenX® mPES membranes demonstrate excellent selectivity as shown in [Figure 6](#).

Figure 5. Membrane performance: MWCO vs. NWP

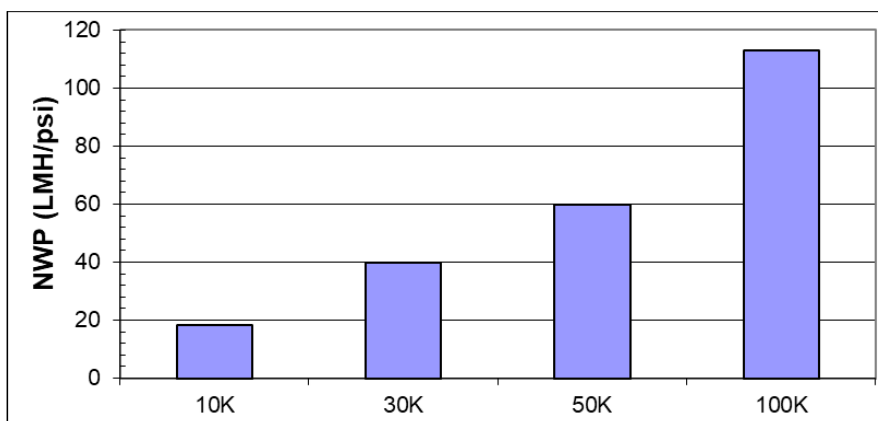
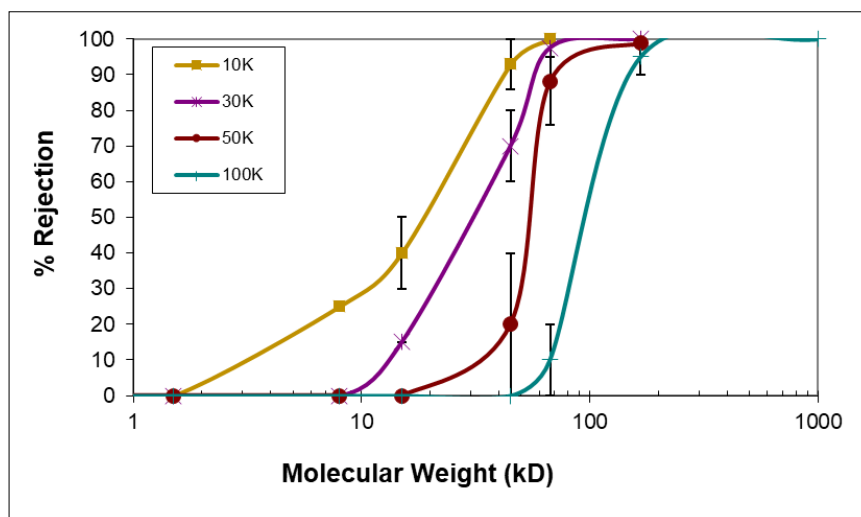

Figure 6. Membrane performance: MW vs. % rejection



4.2 Non-specific protein binding

Non-specific protein binding is defined as the adsorption of a protein to a surface by one or more modes of attraction (e.g., charge effect, hydrophobic interaction, etc.). Non-specific protein binding is associated with yield loss and membrane fouling; both are undesirable effects.

Non-specific protein binding was quantified for ProStream and HyStream mPES membrane chemistries relative to a PES control membrane. One membrane of each type was chosen since the

membrane chemistry is the same for each pore size. Each membrane was challenged with three different types of protein solution: BSA (bovine serum albumin), IgG (immunoglobulin G), and Cyt C (cytochrome c). These proteins were selected because they represent a broad range of molecular weights, structures, and isoelectric points. The amount of protein bound to each membrane was measured by absorbance at 280 nm and then recorded.

As compared to the PES control membrane, both ProStream and HyStream mPES membranes bind relatively less BSA, IgG, and Cyt C ([Table 6](#); average of three different data sets is shown).

Table 6. Non-specific protein binding test results

Membrane type	BSA binding ($\mu\text{g}/\text{cm}^2$)	IgG binding ($\mu\text{g}/\text{cm}^2$)	Cyt C binding ($\mu\text{g}/\text{cm}^2$)
PES control	< 0.1	11.34	36.73
ProStream mPES	< 0.1	2.99	1.36
HyStream mPES	< 0.1	3.29	9.21

Lower protein binding is a desirable attribute of mPES membranes as lower binding is associated with higher product recovery. Additionally, lower protein binding decreases the likelihood of a secondary boundary layer forming on the membrane's surface, which can reduce productivity.

Non-specific protein binding data support the description of Repligen manufactured ProStream and HyStream mPES membranes as "low protein binding" as compared to an unmodified PES membrane.

4.3 Cassette hydraulic performance

Scale-up performance is critical for successful process development and can be demonstrated by evaluating TFF cassette hydraulic performance using purified water. TangenX® SIUS® Gamma Cassettes are manufactured with specific channel geometries and hydrodynamic characteristics that directly impact process performance. Proper channel type selection is critical for scalable performance. This leaves the end user with two primary factors to consider:

- The effect of channel type on the process flux and selectivity profile.
- Linear scaling performance from 0.1 m² to the 10 m².

The TangenX® SIUS® Gamma TFF Devices address these factors, as significant development has been devoted to the channel design. Optimized channel geometry, with enhanced rigidity ensures hydraulic performance is maintained when scaling up through the TangenX® SIUS® Gamma TFF Device family resulting in optimal and reproducible scaling performance. Additionally, each device undergoes rigorous QA release testing to verify it meets specification. Devices are tested for both air integrity and for their hydrodynamic performance. This testing ensures consistent performance from device-to-device; the result is scalable process development and reproducible manufacturing.

To evaluate hydraulic scalability, the pressure drop between the feed and the retentate at 10 psi must be within the specified range of 4- 8 L/min/m² for the L-screen cassette. The pressure drop between the feed and the retentate at 5 psi must be within the specified range of 6 - 12 L/min/m² for the E-screen cassette ([Table 7](#)).

Table 7. Recommended crossflow rates

	Crossflow range	Low crossflow	Medium crossflow	High crossflow	ΔP
L-screen	4 - 8 L/min/m ²	4 L/min/m ²	6 L/min/m ²	8 L/min/m ²	10 psi (0.7 bar)*
E-screen	6 - 12 L/min/m ²	6 L/min/m ²	9 L/min/m ²	12 L/min/m ²	5 psi (0.35 bar)*

*Typical ΔP measured with water and permeate closed.

Comparing the pressure drop (D.P.) of TangenX® SIUS® PD Cassettes vs. the pressure drop of TangenX® SIUS® Gamma PD TFF Devices with equal cassette surface area (0.1 m²) and equivalent channel configuration (L-screen) demonstrates comparable channel geometry across the two products. [Figure 7](#) shows the pressure drop versus cross flow at 10 psi for TangenX® SIUS® PD Cassettes (blue) and TangenX® SIUS® Gamma PD TFF Devices (red). The upper and lower specification limits for the 0.1 m² cassettes at a D.P. of 10 psi are labeled with a dashed green line (0.80 LPM and 0.40 LPM, respectively).

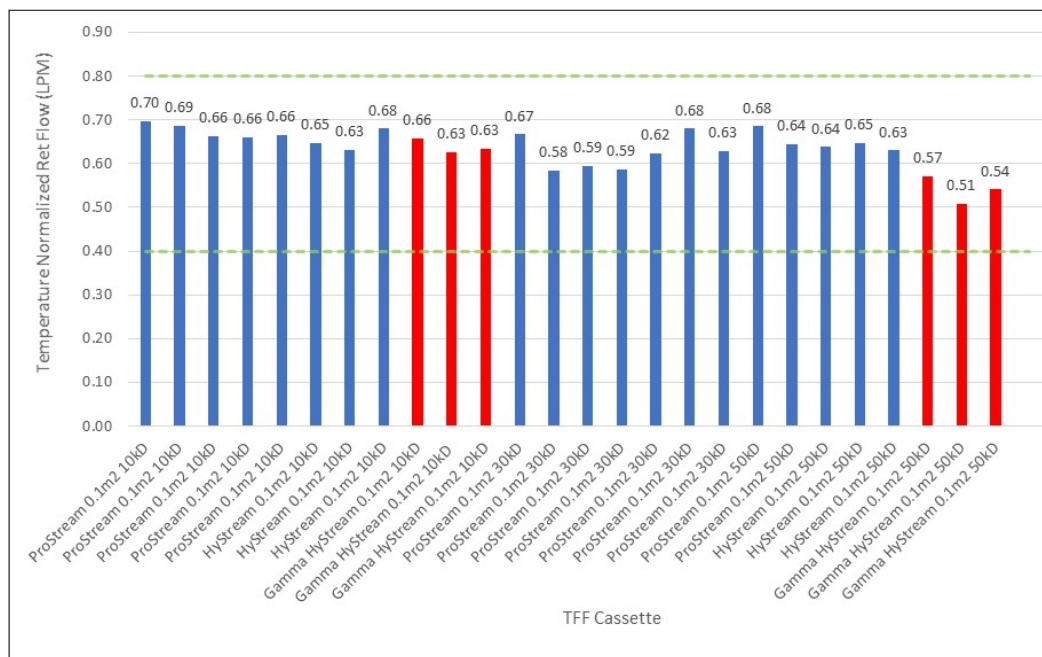
Figure 7. Cross flow flux at 10 psi D.P. for TangenX® SIUS® PD

D.P. vs. crossflow data ([Figure 7](#)) show that both TangenX® SIUS® Cassettes and TangenX® SIUS® Gamma TFF Devices have average temperature normalized retentate flow rates within the required specifications.

Specifications for crossflow vs D.P. at 10 psi are:

- 0.4 LPM - 0.8 LPM for 0.1 m² cassettes
- 2 LPM - 4 LPM for 0.5 m² cassettes
- 6 LPM - 12 LPM for 1.5m² cassettes

Specifications for crossflow vs D.P. at 5 psi are:

- 5 LPM - 10 LPM for 2.5 m² cassettes
- 10 LPM - 20 LPM for 5 m² cassettes
- 20 LPM - 40 LPM for 10 m² cassettes

A cassette’s hydraulic scalability can also be evaluated using purified water to measure normalized water permeability (NWP). NWP data can be used to further support scalability of the TangenX® SIUS® Gamma Cassette product line. [Figure 8](#) shows average NWP values for TangenX® SIUS® Cassettes (blue) vs TangenX® SIUS® Gamma TFF Devices (red); 30 kD ProStream membranes with surface area ranging from 0.1 m² - 2.5 m² were compared. NWP for all TangenX® SIUS® Gamma TFF Device formats were comparable to the corresponding TangenX® SIUS® Cassette. NWP was within specification throughout the entire product range from 0.1 m² – 2.5 m² (24 – 41 LMH/psi). [Figure 9](#) shows average NWP values for the TangenX® SIUS® Gamma TFF Devices with 10 kD ProStream membranes and a cassette surface area ranging from 0.1 m² – 10 m²; NWP was within specification (dashed green lines; 8.6 – 20 LMH/psi) throughout the entire product range from 0.1 m² - 10 m².

Figure 8. NWP for 30 kD TangenX® SIUS® and TangenX® SIUS® Gamma TFF Devices

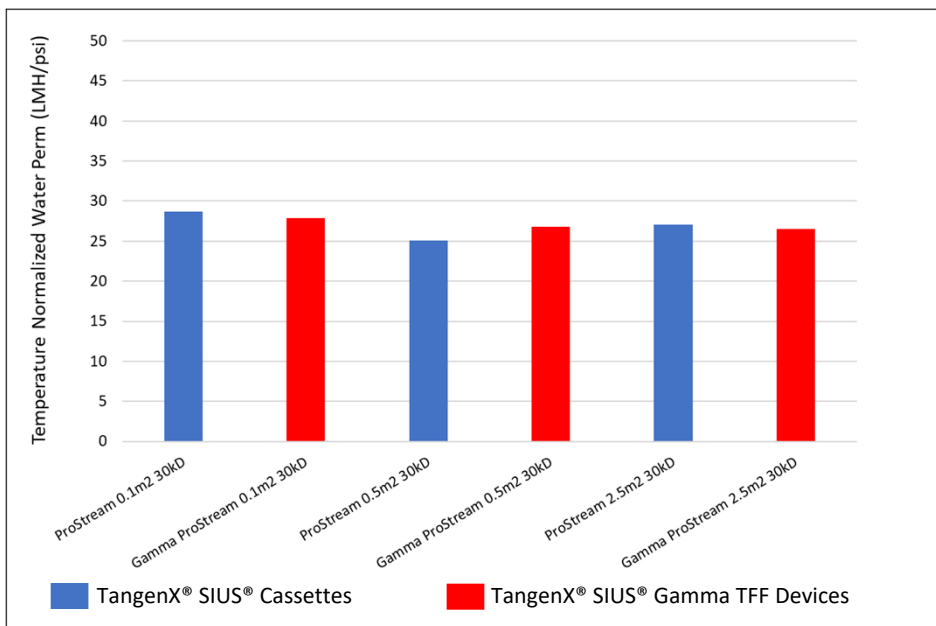
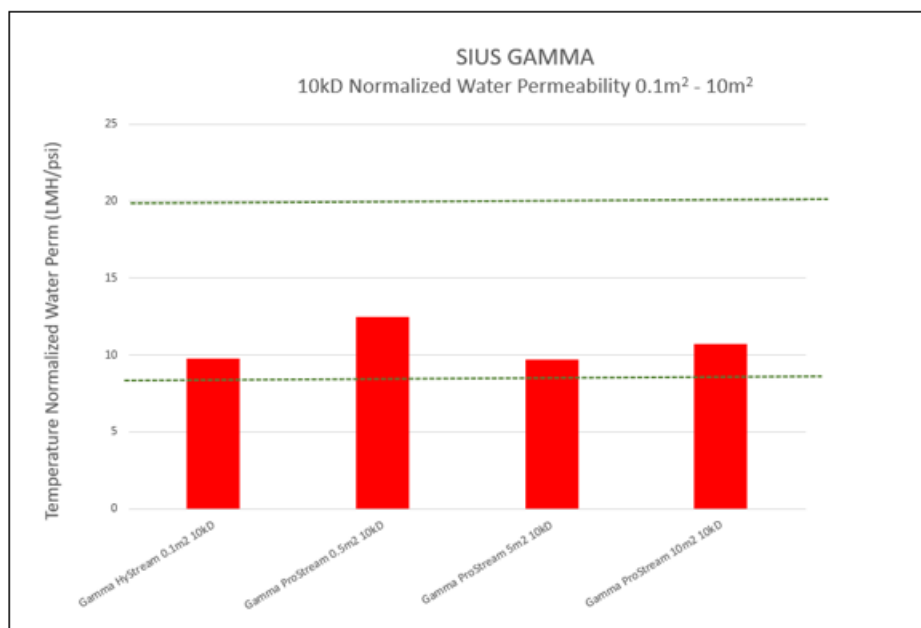

Figure 9. TangenX® SIUS® Gamma TFF Device surface area vs. water flux



A membrane's normalized water permeability (NWP) is a function of its molecular weight cutoff (MWCO). Therefore, there is a range of permeability rates for each cassette of a given MWCO. [Table 8](#) shows typical water permeability rates for the TangenX® SIUS® Gamma TFF Devices with L-screen channel configuration. It is important to note that external influences such as manifolds, piping, and valves create restrictions and can affect the measured NWP. Thus, the initial NWP of your cassette should be measured in its designated system. Typical normalized water permeability (NWP) ranges for a given molecular weight cutoff (MWCO) are shown in [Table 8](#). These values may be used as a guide to determine if a cassette's NWP is within specification.

Table 8. Typical NWP range for TangenX® SIUS® Cassettes

MWCO	Typical NWP range (LMH/psi)
10 kD	8.6 - 20
30 kD	24 - 41
50 kD	34 - 56
100 kD	32 - 91
300 kD	190-300

4.4 Cassette integrity

Cassette integrity testing provides a non-destructive method for verifying the integrity of a Tangential Flow Filtration (TFF) cassette. Each cassette manufactured by Repligen undergoes strict release testing, including an air integrity test. Release testing at Repligen follows a validated test method for cassette QC testing. This procedure refers to ultrafiltration and microfiltration cassettes manufactured by Repligen.

To demonstrate the sensitivity of the air diffusion test, a cassette was tested for integrity where the upstream side of the cassette was pressurized with air. The integral membrane did not allow significant amounts of air to pass through the membrane due to the surface tension of liquid in the pores ([Table 9](#)). The effectiveness of the method was demonstrated by creating a pinhole in a cassette ([Figure 10](#)) and measuring airflow before and after the pinhole was created.

Figure 10. Membrane surface with pinhole (100x magnification)



[Table 9](#) summarizes the integrity testing results for intact (initial) and modified (purposely defected) cassettes. The pinhole defect in the membrane allowed air to pass through the membrane and the flow was measured. Airflow between the initial sample and the modified sample differed by nearly 100-fold. The difference was specific to the air diffusion rate and not the liquid cross flow rate. The

difference between the two liquid flow rates was not affected and no difference in liquid flow was detected. Air integrity specifications for the cassette are shown in [Table 10](#).

Table 9. Cassette integrity test results

Cassette serial #	Cassette status	Results		Results within spec (Y/N)	Difference observed air diffusion (Y/N)	Difference observed flow rate (Y/N)
		Air diffusion rate (ccm)	Liquid flow rate (mL/min)			
17213102	Initial	24	621	Yes	N/A	N/A
	Modified	2196	620	No	Yes	No

Table 10. Cassette integrity specifications

Cassette channel type	Membrane type	Specification
L-screen	Ultrafiltration 10 kD - 300 kD	≤ 323 ccm/m ² at 0.5 bar (≤ 30 ccm/ft ² at 7.3 psi)
E-screen		

4.5 Cassette pre-flushing

TangenX® SIUS® Gamma TFF Devices require a purified water flush and buffer equilibration step prior to use to ensure leachable concentration reduction. The method developed to flush the cassette prior to use was developed to maximize the efficiency of the flushing process and reduce the total amount of required water and buffer. Storage agents removed by flushing may be considered unwanted leachables by the user if not sufficiently removed by the specified rinse and equilibration procedure recommended by Repligen. The following summary outlines the recommended flushing conditions developed to remove the storage solution and unwanted leachables from the cassette.

Flushing the TangenX® SIUS® Gamma TFF Device with 0.2 micron filtered deionized (DI) water displaces 0.2 N NaOH present in the shipped product and prepares it for use.

4.5.1 Purified water flush

Cassettes were flushed by connecting a vessel filled with purified water to the cassette and directing the flow path from the water vessel to the cassette. Flow was directed out of the retentate port of the cassette device to a waste vessel ([Figure 11](#)). A vessel containing purified DI water was directed through a pump to the inlet of the cassette. The retentate flow path was flushed at the recommended flow rate of the feed pump specified in [Table 7](#). Water was flushed through the retentate to waste until 5 L of water per m² surface area was collected in the waste vessel as specified in [Table 11](#). The permeate was connected to the waste vessel through the permeate outlet port. The permeate flow path was then flushed opening permeate and closing the retentate. The water was pumped from the water vessel, into the feed port, through the device, through the permeate into a waste vessel. The pump was initially started at a low flow rate and slowly increased it until the transmembrane pressure was 10 - 15 psi. The permeate was flushed until 10 L of water per m² surface area was collected in the permeate to waste vessel.

Figure 11. Example device flush flow path

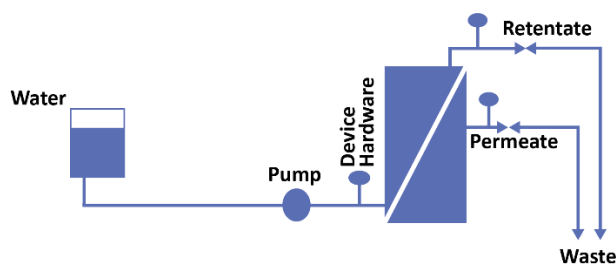

Table 11. Normalized device flush volumes

TFF filter surface area	Retentate to waste	Permeate to waste
0.1 m ²	0.5 L	1.0 L
0.5 m ²	2.5 L	5.0 L
1.5 m ²	7.5 L	15.0 L
2.5 m ²	12.5 L	25.0 L
5 m ²	25 L	50 L
10 m ²	50 L	100 L

4.5.2 Buffer equilibration

The cassette device was then equilibrated with buffer to neutralize residual NaOH, the storage solution in the TangenX® SIUS® Gamma TFF Device. A buffer vessel was connected to the feed and the cassette was flushed with the buffer solution in a comparable manner to the water flush. Flow was directed out of the retentate port of the cassette device to a waste vessel (Figure 12). A vessel containing buffer was directed through a pump to the inlet of the cassette. The retentate flow path was flushed at the recommended flow rate of the feed pump specified in Table 7. Buffer was flushed through the retentate to waste until 5 L of water per m² surface area and collected in the waste vessel as specified in Table 12. The permeate was connected to the waste vessel through the permeate outlet port. The permeate flow path was then flushed opening permeate and closing the retentate. The buffer was pumped from the water vessel, into the feed port, through the device, through the permeate into a waste vessel. The pump was initially started at a low flow rate and slowly increased it until the transmembrane pressure was 10 - 15 psi. The permeate was flushed until 10 L of buffer per m² surface area was collected in the permeate to waste vessel.

Figure 12. Example buffer equilibration flow path

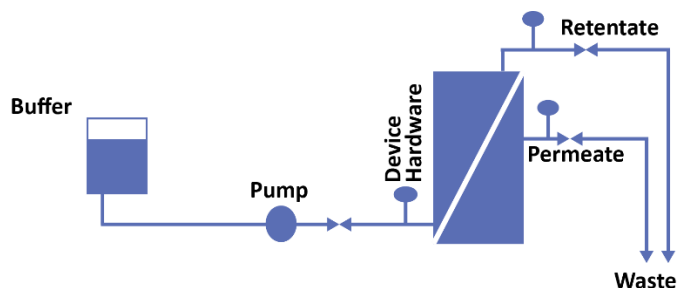

Table 12. Buffer equilibration volumes

TFF filter surface area	Retentate to waste	Permeate to waste
0.1 m ²	0.5 L	1.0 L
0.5 m ²	2.5 L	5.0 L
1.5 m ²	7.5 L	15.0 L
2.5 m ²	12.5 L	25.0 L
5 m ²	25 L	50 L
10 m ²	50 L	100 L

This pre-flushing method was used to prepare the cassettes for the BPOG extractables study demonstrating the effectiveness of the method. Cassette preparation protocol TX1001-POQ-160 provided methods to be followed while preparing the single-use TangenX® SIUS® Gamma TFF Device for BPOG extractables testing to be performed by an accredited analytical laboratory. This procedure was used to provide a record of the samples to be prepared, as well as the method of preparation of the cassettes for the BPOG extractables testing. Further information related to leachables and extractables studies are detailed in [Section 5.2](#) of this document.

4.6 Robustness study

TangenX® SIUS® Gamma TFF Devices are designed to be single use; however, the cassette must demonstrate the robustness to withstand use under the full range of recommended conditions. Many different elements contribute to the stress put onto TFF cassettes: time, temperature, pressure, flow rate, and buffer conditions are several examples. Several steps were taken to validate the robustness of the TangenX® SIUS® Gamma TFF Devices under aggressive operating conditions. The information gathered from this validation study will also be referenced in other supporting documents. Six (6) 0.1 m² TangenX® SIUS® Gamma PD TFF Device and six (6) 0.5 m² TangenX® SIUS® Gamma TFF Devices were manufactured, irradiated, then evaluated for robustness. Each device was prepared using current SOPs to reflect the standard manufacturing process at Repligen. The following steps were taken as part of the study:

1. TangenX® SIUS® Gamma PD TFF Devices were prepared using the following procedures:
 - POP-SOP-1044 Single-use Cassette Assembly Procedure
 - POP-SOP-1048 Filter Plate Preparation Procedure
 - POP-SOP-1058 TangenX® SIUS® Gamma Cassette Assembly Procedure
2. Cassettes were sampled and evaluated following procedure TX1001-POQ-159.

This study followed the approved method TX1001-POQ-159 for evaluation of TangenX® SIUS® Gamma TFF Devices for durability and robustness. Each device was tested and released following the TangenX® SIUS® QC test procedure POP-SOP-1033. A total of twelve different TangenX® SIUS® Gamma TFF Devices were selected for this study, representative of the entire product line of closed cassettes. ProStream and HyStream membrane chemistries were included. The molecular weight cutoffs (MWCO) tested ranged from 10 kD - 300 kD, representative of the entire product offering. A summary of the devices used for the study is shown in [Table 13](#), each was tested in triplicate.

Each device was removed from its packaging, installed in a cassette holder, and then equilibrated with PBS buffer. Baseline air integrity, normalized water flux (NWP), and pressure drop were measured and recorded. PBS buffer was then recirculated through the system for 8 hours at 4°C and 40°C. Once this recirculation was complete, the devices were retested for air integrity, NWP, and pressure drop. All devices met the release specifications ([Table 13](#)).

Table 13. Robustness testing

Part number	Description	Result
XP010C01L	0.1 m ² TangenX® SIUS® Gamma PD TFF Devices (10 kD ProStream)	Pass
PP100C01L	0.1 m ² TangenX® SIUS® Gamma PD TFF Devices (100 kD HyStream)	Pass
XP010F05L	0.5 m ² TangenX® SIUS® Gamma TFF Devices (10 kD ProStream)	Pass
PP100F05L	0.5 m ² TangenX® SIUS® Gamma TFF Devices (100 kD HyStream)	Pass

Each cassette type met the post-use integrity and pressure drop specifications. Integrity is one of the best indicators of an issue with the cassette and is critical to its function. The robustness testing demonstrated the design of the cassette stack remained integral following the challenge conditions.

4.7 Shelf life study

4.7.1 Membranes

The following section describes the conclusion of the shelf life study for ultrafiltration membranes manufactured by Repligen after five years. Ultrafiltration membranes are initially cast and then stored for a period of time prior to being incorporated into a cassette product. The time between when the membrane is manufactured and when it is used in a cassette may be up to five (5) years.

Several lots of membranes were cast during the process validation; each membrane was prepared using current SOPs and reflected the standard membrane manufacturing process at Repligen. The following steps were taken as part of the study:

- Membranes were prepared using POP-SOP-1027 and POP-SOP-1028
- These membranes were sampled and tested following TX1001-POQ-115

This summary will provide final results for the shelf life study of the ProStream and HyStream membranes manufactured at Repligen. This report will also be used to summarize results of the sampling and testing throughout the study. The membrane storage study procedure TX1001-POQ-115 was applied to both the ProStream and HyStream membranes manufactured at Repligen. One membrane of each type was chosen to represent the product line consisting of all MWCO membranes. These membranes were chosen as they correspond to the cassette storage study. Each membrane was tested following the standard Repligen QC release procedure POP-SOP-1030.

Membrane acceptance criteria for shelf life results are show in [Figure 13](#). The storage study was executed at two different temperatures, one at ambient temperature ([Table 14](#)) and the other at 50°C ([Table 15](#)). Ambient simulated exposure at a “normal” or median temperature. This type of study spanned five (5) years and was the standard shelf life study. Experiments at 50°C simulated exposure to the maximum temperature limit of the product as an accelerated stability study.

Data for each time point was obtained in triplicate. In the event one membrane failed during the study, a failure analysis would have been conducted through the deviation procedure (PAQ-SOP-1030). Failure mode and product quality impact would have then been assessed. If the membrane was deemed to be an anomaly, the study would have continued as planned. The documented failure would have accompanied the final report. Failure of all three membranes would have concluded the study. A detailed analysis of the membranes that did not meet release criteria would have been included in the final report.

Figure 13. Membrane acceptance criteria for shelf life results

Normalized Water Permeability	NWP
NWP (LMH/psi)	9.5 - 22.0 LMH/psi
Percent deviation	15%
Passing molecular weight (MW) marker	PVP C-15 (~15 kD)
Flux (LMH)	140 - 250 LMH
Percent rejection	30% - 60%
Retaining molecular weight (MW) marker	PVP C-30 (~45 kD)
Flux (LMH)	75 - 110 LMH
Percent rejection	> 85%
Integrity test	Air diffusion @ 15psi
Total number of discs with air diffusion	≤ 6 (of 18 discs)

Table 14. Membrane acceptance test results: Ambient temperature

Time point	Normalized water permeability	Passing MW marker	Retaining MW marker	Integrity test
Time initial	Pass	Pass	Pass	Pass
3 months	Pass	Pass	Pass	Pass
6 months	Pass	Pass	Pass	Pass
1 year	Pass	Pass	Pass	Pass
2 years	Pass	Pass	Pass	Pass
3 years	Pass	Pass	Pass	Pass
4 years	Pass	Pass	Pass	Pass
5 years	Pass	Pass	Pass	Pass

Table 15. Membrane acceptance test results: Elevated temperature (50°C)

Time point	Normalized water permeability	Passing molecular weight marker	Retaining molecular weight marker	Integrity test
Time initial	Pass	Pass	Pass	Pass
1 week	Pass	Pass	Pass	Pass
1 month	Pass	Pass	Pass	Pass

4.7.2 Conclusions

The results demonstrate that both the ProStream and HyStream membranes meet or exceed all release specifications after five years at ambient conditions ([Table 14](#)) and one month at 50°C ([Table 15](#)). No significantly measurable change in membrane performance was detected. The membrane storage study successfully reached its 5-year conclusion.

4.7.3 TangenX® SIUS® Gamma TFF Devices

The following section describes the method used to evaluate the shelf life of the TangenX® SIUS® Gamma TFF Devices manufactured by Repligen. The TangenX® SIUS® Gamma TFF Devices are manufactured, packaged, irradiated, and stored for a period of time prior to shipment. Once shipped, the device may then remain in storage for an additional period of time before it is put into use. The SIUS Gamma Single-use devices are stable for up to 6 months at elevated temperature and 3 years when stored at ambient temperature.

TangenX® SIUS® Gamma TFF Devices were manufactured and evaluated in triplicate. Each device was prepared using Repligen SOPs conforming to the Repligen standard manufacturing process. The following steps were taken as part of the study:

1. Devices were prepared using best manufacturing practices.
2. These devices were sampled and studied following this procedure.

Procedure TX1001-POQ-164 was used to evaluate shelf-life stability, including determination of appropriate time points for sampling and evaluation. Each device was evaluated in accordance with the Repligen standard QC release procedure and acceptance criteria ([Table 16](#)).

Table 16. TangenX® SIUS® Cassette acceptance criteria

Acceptance per DID-18159 (R0)	Limit
Bioburden (ANSI/AAMI/ISO 11137-1)	< 10 CFU / 100 mL
Endotoxin (ANSI/AAMI/ISO ST72 :2011, <85>)	< 0.25 EU/mL
Total organic carbon (USP 41, <643>)	< 0.5 mg/cm ²
Pressure drop vs cross flow @ D.P. 10 psi	0.4 - 0.8 LPM
Air diffusion test @ 7.3 psi (0.5 bar)	< 30 ccm

One device format with two different membrane chemistries was chosen for this study, i.e., 0.1 m² TangenX® SIUS® Gamma PD TFF Devices with 10 kD ProStream (n = 3) and 10 kD HyStream (n = 3) membranes. The 0.1 m² TangenX® SIUS® Gamma PD TFF Device was chosen as it accurately represents the construction of the entire product line, including surface areas up to 5 m². The two membrane types represent the entire TangenX® SIUS® Gamma TFF Device product portfolio manufactured by Repligen. The shelf-life study consists of two different temperatures, one at ambient temperature and the other at 50°C. Ambient temperature experiments simulate exposure to a “normal” or median temperature. This type of study demonstrates the shelf-life to be three (3) years. Experiments at 50°C provide accelerated aging data and has been designed to simulate exposure at the maximum temperature limit of the product. The study period of 6 months for the accelerated aging was calculated following the ASTM reference F1980-16 (see [Section 2](#)). This portion of the study was concluded within six (6) months and is considered an accelerated study. A study at lower temperatures is not within scope of this study plan.

In the event of a single device failure, a failure analysis will be conducted through the deviation process summarized in the procedure. The failure mode and impact on product quality will also be assessed. If the observed failure is deemed to be an anomaly, the study will continue as planned. The documented failure will accompany the final report. If two or more devices fail at any one time point, the study will be concluded. A detailed analysis of the devices that did not meet release criteria will be conducted and will be included in the final report. This study will be submitted at two times, once in an interim report issued after six months and one final report after three years.

4.7.4 Results

TangenX® SIUS® Gamma PD TFF Devices with 0.1 m² cassette surface area, L-screen channel configuration, and either a 10 kD ProStream (n = 3) or a 10 kD HyStream (n = 3) membrane passed accelerated aging shelf-life testing at both initial and six-month time points ([Table 17](#)). Acceptance criteria (bioburden, endotoxin, TOC, pressure drop, and air diffusion) for the TangenX® SIUS® Gamma TFF Device shelf-life study was identical to those of the TangenX® SIUS® Cassette ([Table 16](#)).

Table 17. Device acceptance test results: Elevated temperature (50°C)

Cassette type	Membrane chemistry, MWCO	Time initial	6 months
TangenX® SIUS® Gamma PD TFF Device, 0.1 m ² L-screen channel	ProStream, 10 kD	Pass	Pass
	HyStream, 10 kD	Pass	Pass

TangenX® SIUS® Gamma PD TFF Devices with 0.1 m² cassette surface area, L-screen channel configuration, and either a 10 kD ProStream (n = 3) or a 10 kD HyStream (n = 3) membrane passed shelf-life testing at ambient temperature at initial, six-month, one-year, two-year and three-year time points (Table 18). Acceptance criteria (bioburden, endotoxin, TOC, pressure drop, and air diffusion) for the TangenX® SIUS® Gamma TFF Device shelf-life study was identical to those of the TangenX® SIUS® Cassette (Table 16).

Table 18. Device acceptance test results: Ambient temperature

Cassette type	Membrane chemistry, MWCO	Time initial	Months 6	Years		
				1	2	3
TangenX® SIUS® Gamma PD TFF Device, 0.1 m ² L-screen channel	ProStream, 10 kD	Pass	Pass	Pass	Pass	Pass
	HyStream, 10 kD	Pass	Pass	Pass	Pass	Pass

4.7.5 Conclusions

This study report describes the final results of the shelf-life storage study of the SIUS Gamma tangential flow filtration cassettes manufactured by Repligen Corporation. Multiple lots of cassettes were manufactured and evaluated in triplicate; each cassette was prepared using current SOP's and reflect the standard cassette manufacturing process at Repligen.

Each of the devices were evaluated to assess the physical integrity, mechanical integrity, product performance, and bioburden level once the device was removed from storage. All measurements met the required specifications shown in the table above. These results indicate that the SIUS Gamma TFF Single-use devices are stable for up to 6 months at elevated temperature and 3-years when stored at ambient temperature.

The results show the tangential flow filtration cassettes meet or exceed all release specifications after both the accelerated study and ambient conditions after three years. Additionally, the cassette's bioburden & endotoxin levels are not affected over 3-years of time. The cassette storage study successfully reached its conclusion and supports a 3-year shelf life under ambient conditions.

4.8 Chemical compatibility

Table 19. ProStream and HyStream membrane chemical compatibility

Reagent	ProStream (pH 1 – 14)	HyStream (pH 1 – 14)
Acetic acid (5%)	✓	✓
Acetic acid (25%)	✓	X
Acetone (≤ 30%)	✓	✓
Acetonitrile (≤ 15%)	✓	✓
Alconox (1%)	✓	✓
Aliphatic and aromatic esters	X	X
Amines	X	X
Ammonium chloride (1%)	✓	✓
Ammonium hydroxide (5%)	X	X
Aromatic and chlorinated hydrocarbons	X	X
Butanol (70%)	✓	✓
Butyl acetate (40%)	✓	X
Butyl cellosolve (10%)	✓	✓
Calcium chloride (5%)	✓	✓
Chloroform (0.8%)	✓	✓
Citric acid (1%)	✓	✓
Dimethyl acetamide (DMAC) (≤ 30%)	✓	X
Dimethyl acetamide (DMAC) (≤ 15%)	✓	✓
Dimethylformamide (≤ 40%)	✓	✓
Dimethyl sulfoxide (≤ 40%)	✓	✓
Disodium salt of EDTA (10%)	✓	✓
Ethanol (70%)		✓
Ethers	X	X
Ethyl acetate (≤30%)	✓	✓
Formaldehyde (1%)	✓	✓
Formic acid (5%)	✓	✓
Glutaraldehyde (0.5%)	✓	✓
Glycerin (50%)	✓	✓
Guanidine HCl (6M)	✓	✓
Hydrochloric acid (0.1N @ 25°C)	✓	✓
Hydrochloric acid (0.1N @ 50°C)	✓	✓
Hydrochloric acid (1.0N @ 50°C)	✓	X
Hydrogen peroxide (1%)	✓	✓
Isopropyl acetate (1%)	✓	✓
Isopropyl alcohol (25%)	✓	✓
Ketones	X	X
Lactic acid (5%)	✓	✓
Mercaptoethanol (0.1%)	✓	✓

Reagent	ProStream (pH 1 – 14)	HyStream (pH 1 – 14)
Methyl alcohol (25%)	✓	✓
Methylene chloride (1%)	✓	X
Methyl ethyl ketone (1%)	✓	X
N-methyl pyrrolidone (1%)	✓	✓
Nitric acid (≤1%)	✓	✓
Oxalic acid (1%)	✓	✓
Phenol (0.5%)	✓	✓
Phosphate buffer (pH: 8.2) (1 M)	✓	✓
Phosphoric acid (1 N)	X	X
Sodium azide (1%)	✓	✓
Sodium chloride (5%) (50°C)	✓	✓
Sodium deoxycholate (5%)	X	X
Sodium dodecyl sulfate (0.01 M)	✓	✓
Sodium hydroxide (0.1 N @ 25°C)	✓	✓
Sodium hydroxide (0.1 N @ 50°C)	✓	✓
Sodium hydroxide (0.5 N @ 25°C)	✓	✓
Sodium hydroxide (0.5 N @ 50°C)	✓	✓
Sodium hydroxide (1.0 N @ 25°C)	✓	X
Sodium hypochlorite (100 ppm)	✓	✓
Sodium hypochlorite (400 ppm)	✓	X
Sodium hypochlorite (1000 ppm)	X	X
Sodium nitrate	✓	✓
Sulfuric acid (1 N)	✓	
Terg-a-zyme (1%)	✓	✓
Tetrahydrofuran (5%)	X	X
Toluene (1%)	X	X
Tris buffer (pH: 8.2) (1 M)	✓	
Triton X - 100 (0.002 M)	✓	✓
Urea (25%)	✓	✓
Ultrasil 11 (1%)	✓	

✓ = Compatible, no significant changes in either rejection or flow rate.

X = Not compatible, significant change noticed.

5. Safety information

5.1 USP Class VI

The purpose of UPS Class VI testing is to verify the biological safety of each of the components used in the TangenX® SIUS® Gamma TFF Device product line. Samples for USP Class VI testing consisted of each of the five components of the TangenX® SIUS® Gamma TFF Device. Each component used to construct the devices is listed in the [Figure 14](#). Sample dimension, sample mass and test regime are identified as well.

Figure 14. USP testing results

TangenX Sample Matrix		USP Testing		Vendor: Toxikon	
	Component Description	Composition	Minimum Sample Mass	Sample Dimensions	Tests to be Conducted
1	Cassette Encapsulant	Polyurethane	~ 45 grams from 3 lots	25mm x 25mm x 5mm ⁽¹⁾	A,B,C
2	Screen Spacer	Polyolefin	~ 45 grams from 3 lots	25mm (diameter) x 0.8mm ⁽¹⁾	A,B,C
3	HyStream Membrane	Polyethersulfone	~ 45 grams from 3 lots	25mm (diameter) x 0.2mm ⁽¹⁾	A,B,C
4	ProStream Membrane	Polyethersulfone	~ 45 grams from 3 lots	25mm (diameter) x 0.2mm ⁽¹⁾	A,B,C
5	EPDM Gasket	EPDM	~ 45 grams from 3 lots	25mm (diameter) x 1mm ⁽¹⁾	A,B,C
6	Silicone PSA w/screen	Silicone & Polypro	~ 45 grams from 3 lots	25mm (diameter) x 0.8mm ⁽¹⁾	A,B,C
⁽¹⁾ Must also include 1mm x 1mm x 10mm sample					
Test ID	Test Description		Sample Mass	Sample Dimensions	Total Qty
A	MEM Elution per USP <87>		4 grams	(see above)	7
B	Class VI per USP <88>		16 grams, plus additional pieces ~10g ⁽¹⁾	(see above), plus 12 pieces 1mmx1mmx10mm	7
C	Hemolysis - Indirect with rabbit blood		15 grams	(see above)	7

Samples for both USP and extractables testing required preparation prior to analysis. Each sample needed to be rinsed with WFI, sanitized with 0.5 M NaOH, and then rinsed again with WFI. The purpose of this sample preparation is two-fold:

1. To simulate the sanitization procedure the end user would perform prior to use of the device.
2. To sanitize the sample so as not to allow external contamination to interfere with the USP testing.

Approved procedures were followed during preparation of samples and used for USP and Class VI testing. The procedure was used to provide a record of the samples to be prepared, as well as the method of preparation. Experimental deviations were recorded in a laboratory notebook and a copy attached to the final report. They were used to describe the deviations, to determine ways to rectify them and to record whether or not they would significantly affect the result of the experiment.

Results and discussion

The results of the studies show that all component materials meet:

- Current requirements for USP Class VI biological testing for plastics
- The test article(s) meets the test requirements as defined in the USP guidelines: USP 30, NF 25, 2007, <788> Particulate Matter in Injections

All components materials used in cassettes manufactured by Repligen have been independently tested for USP safety and were shown to be safe according to:

- L929 MEM Elution per USP <87>

- Class VI per USP <88>
- Hemolysis - Indirect with Rabbit Blood

The study proposal for the USP testing conducted with Toxikon® is found in Toxikon® laboratory proposal #07-2-26TF7757 and #08-5-8TF9874. The study results generated by Toxikon® are found in the complete USP report that can be provided by Repligen. A summary of the test results is below ([Figure 15a](#) and [15b](#)).

Figure 15. Summary of USP testing results

a)



Test Summary

Date: Oct.27, 2008
 Sponsor: TangenX Technology Corp.
 Contact: Mark Pereaault

Test Article Number: 08-2554
 Test Material: EPDM Gasket

Test Name	Project #	Status / Results
MEM Elution-USP	08-2554-G1	PASS – Report Complete
Class 6 (includes implant)	08-2554-G2	PASS - Report Complete
Hemolysis/ extract/ Rabbit Blood	08-4577-G1	PASS – Report Complete

Test Article Number: 08-2555
 Test Material: Silicone PSA with Screen

Test Name	Project #	Status / Results
MEM Elution-USP	08-2555 -G1	PASS – Report Complete
Class 6 (includes implant)	08-2555 -G2	PASS - Report Complete
Hemolysis/ extract/ Rabbit Blood	08-2555 –G3	PASS – Report Complete

Test Article Number: 07-1878
 Test Material: ProStream (BioFlo) PES Membrane

Test Name	Project #	Status / Results
MEM Elution-USP	07-1878-G1	PASS- Report Complete
Class 6 (includes implant)	07-1878-G2	PASS - Verbal 5/29PASS - Report Complete
Hemolysis/ extract/ Rabbit Blood	07-1878-G3	PASS – Report Complete

b)



Test Article Number: 07-1880
Test Material: Screen Spacer

Test Name	Project #	Status / Results
MEM Elution-USP	07-1880-G1	PASS – Report Complete
Class 6 (includes implant)	07-1880-G2	PASS - Report Complete
Hemolysis/ extract/ Rabbit Blood	07-1880-G3	PASS – Report Complete

Test Article Number: 07-1881
Test Material: Channel Spacer

Test Name	Project #	Status / Results
MEM Elution-USP	07-1881-G1	PASS – Report Complete
Class 6 (includes implant)	07-1881-G2	PASS - Report Complete
Hemolysis/ extract/ Rabbit Blood	07-1881-G3	PASS – Report Complete

Test Article Number: 07-1882
Test Material: Cassette Encapsulant

Test Name	Project #	Status / Results
MEM Elution-USP	07-1882-G1	PASS – Report Complete
Class 6 (includes implant)	07-1882-G2	PASS - Report Complete
Hemolysis/ extract/ Rabbit Blood	07-1882-G3	PASS – Report Complete

Test Article Number: 07-1885
Test Material: HyStream (HyFlo) PES Membrane

Test Name	Project #	Status / Results
MEM Elution-USP	07-1885-G1	PASS – Report Complete
Class 6 (includes implant)	07-1885-G2	PASS - Report Complete
Hemolysis/ extract/ Rabbit Blood	07-1885-G3	PASS – Report Complete

Note: Test article identified as BioFlo® is ProStream. Test article identified as HyFlo® is HyStream.

5.2 Cassette leachables and extractables (L and E) following BPOG

A controlled extraction study was performed on the TangenX® SIUS® Gamma TFF Device (and tubing components) using solvents and extraction techniques across a broad range of polarities. The methodology utilized were described in the study plan TX1001-POQ-160 and results generated are summarized in Study Report 10827-19-3528. The results generated during this study represent the 2014 BPOG recommended study conditions. They present a worst-case scenario, since neither the temperature nor dissolution properties of the solvents used during this investigation are more aggressive compared to the solvents used during routine component exposure.

Several different TangenX® SIUS® Gamma TFF Devices with tubing sets were manufactured and then evaluated for extractables following the latest guidance outlined by BPOG. Each cassette device was prepared using current SOPs and reflected the standard manufacturing process at Repligen. The following steps were taken as part of the study:

- TangenX® SIUS® Gamma Tubing Assemblies were prepared according to approved procedures.
- TangenX® SIUS® Gamma TFF Devices were prepared using POP-SOP-1058 and meet release criteria established by Repligen.

Test samples were initially received by the contracted laboratory, flushed with purified water to remove the storage solution, then equilibrated with the extraction solution. Extraction of the test samples was performed using 50% ethanol in USP purified water, 1% polysorbate-80, 5 M sodium chloride, 0.5 M sodium hydroxide, 0.1 M phosphoric acid, and purified water (WFI). Samples were extracted for 0.5 hours, 24 hours, and 21 days at 40°C. Each cassette sample was composed of three different lots of membrane forming a composite sample. The test articles were agitated using a

rocking table for the entire duration of the extraction. Once the sample time point was reached, the extraction fluid was drained from the cassette device and analyzed for extractables. The following is a summary of the testing performed.

HPLC/DAD/MS was performed on selected component extracts according to the conditions as described in the study plan. All sample extracts were analyzed for antioxidants and additives by HPLC-DAD/MS with the DAD operating at the 220 nm wavelength, and the MS operating in ESI (\pm) and APCI (\pm) modes. A number of both known and unknown extractable peaks were identified in all sample extracts. Concentrations of BPA were quantified using the response of an authentic reference standard. Concentrations for all other analytes were determined using the response factor for the internal standard for each sample injection. All peaks greater than 0.1 $\mu\text{g}/\text{mL}$ that were detected in the sample extracts at levels 1.5x higher than in the associated method control are reported as extractables. Results are available in the study report 10827-19-3528; summarized in Tables 3 – 4.

GC/MS was performed on selected component extracts according to the conditions as described in the study plan. All sample extracts were assayed for semi-volatiles by GC/MS. A number of both known and unknown analytes were detected in the all sample extracts. Concentrations of 1,3-di-tert-butylbenzene, and 2,4-di-tert-butylphenol were quantified using the response of an authentic reference standard. Concentrations of all other analytes were determined using the response factor for the internal standard for each sample injection. Results are available in the study report 10827-19-3528; summarized in Tables 24 – 25.

Headspace GC/MS was performed on selected component extracts according to the conditions as described in the study plan. All sample extracts were assayed for volatiles by HS-GC/MS. A number of tentatively identified analytes were detected in the 50% ethanol and 1% PS-80 sample extracts. Concentrations of 1,3-di-tert-butylbenzene were quantified using the response from an authentic reference standard. Concentrations of all other analytes were determined using the response factor for the internal standard for each sample injection. Results are available in the study report 10827-19-3528; summarized in Tables 45 – 46.

Induction Coupled Plasma / MS was performed on selected component extracts according to the conditions as described in the study plan. All sample extracts were outsourced to Chemical Solutions, Ltd. for metals analysis by ICP/MS. Results are available in the study report 10827-19-3528; summarized in Tables 66 – 67.

TOC, pH, and Non-Volatile Residue analysis were performed on selected component extracts according to the conditions as described in the study plan. Results for total organic carbon, pH, and non-volatile residue are provided in Tables 20 - 32 below. For TOC analysis of the 5 M NaCl extracts, a dilution was required due to an adverse matrix effect on the instrumentation. For all other sample extracts, dilutions were required to be within the calibration curve.

Table 20. TOC results summary

Sample description	Extraction solvent	30 minutes		Results 1 day		21 day	
		µg C/mL	µg C/cm ²	µg C/mL	µg C/cm ²	µg/mL	µg/cm ²
Cassette assembly	WFI	65.2	5.82	187	16.7	499	44.5
	0.5 N NaOH	47.9	4.27	179	15.9	622	55.5
	0.1 M H ₃ PO ₄	46.1	4.12	167	14.9	470	41.9
	5 M NaCl	< 1.00	< 0.0892	1.96	0.175	4.67	0.416
Tube set	WFI	3.64	0.604	36.8	6.05	694	109
	0.5 N NaOH	4.44	0.758	51.0	8.60	816	131
	0.1 M H ₃ PO ₄	4.21	0.708	41.8	6.88	780	122
	5 M NaCl	< 1.00	< 0.169	< 1.00	< 0.168	7.04	1.14

Table 21. pH results summary

Sample description	Extraction solvent	30 minutes		Results 1 day		21 day	
Cassette assembly	WFI	9.7		10.2		9.9	
	0.5 N NaOH	1.7		1.8		1.8	
	0.1 M H ₃ PO ₄	13.3		13.3		13.3	
	5 M NaCl	8.6		9.2		8.9	
Tube set	WFI	7.5		6.2		4.0	
	0.5 N NaOH	1.7		1.7		1.7	
	0.1 M H ₃ PO ₄	13.4		13.3		13.3	
	5 M NaCl	6.6		6.2		3.5	

Table 22. Non-volatile residue results summary

Sample description	Extraction solvent	30 minutes		Results 1 day		21 day	
		µg C/mL	µg C/cm ²	µg C/mL	µg C/cm ²	µg/mL	µg/cm ²
Cassette assembly	WFI	151	13.5	494	44.1	1.32E+03	118
	50% EtOH	809	72.2	966	86.2	1.88E+03	168
Tube set	WFI	< LOQ	< LOQ	< LOQ	< LOQ	< LOQ	< LOQ
	50% EtOH	< LOQ	< LOQ	37.5	6.20	75.8	8.28

Table 23. TOC results for 30-minute sample extracts

Sample description	Extraction solvent	Chemic sample ID	Result	
			µg/mL	µg/cm ²
Cassette assembly	WFI	TST062019-02C-6-5A	65.2	5.82
	0.5 N NaOH	TST062019-02C-4-5A	47.9	4.27
	0.1 M H ₃ PO ₄	TST062019-02C-5-5A	46.1	4.12
	5 M NaCl	TST062019-02C-3-5A	< 1.00	< 0.0892
Tube set	WFI	TST062019-03C-6-5A	3.64	0.604
	0.5 N NaOH	TST062019-03C-4-5A	4.44	0.758
	0.1 M H ₃ PO ₄	TST062019-03C-5-5A	4.21	0.708
	5 M NaCl	TST062019-03C-3-5A	< 1.00	< 0.169

Table 24. TOC results for 1-day sample extracts

Sample description	Extraction solvent	Chemic sample ID	Result	
			µg/mL	µg/cm ²
Cassette assembly	WFI	TST062019-02B-6-5A	187	16.7
	0.5 N NaOH	TST062019-02B-4-5A	179	15.9
	0.1 M H ₃ PO ₄	TST062019-02B-5-5A	167	14.9
	5 M NaCl	TST062019-02B-3-5A	1.96	0.175
Tube set	WFI	TST062019-03B-6-5A	36.8	6.05
	0.5 N NaOH	TST062019-03B-4-5A	51.0	8.60
	0.1 M H ₃ PO ₄	TST062019-03B-5-5A	41.8	6.88
	5 M NaCl	TST062019-03B-3-5A	< 1.00	< 0.168

Table 25. TOC results for 21-day sample extracts

Sample description	Extraction solvent	Chemic sample ID	Result	
			µg/mL	µg/cm ²
Cassette assembly	WFI	TST062019-02A-6-5A	499	44.5
	0.5 N NaOH	TST062019-02A-4-5A	622	55.5
	0.1 M H ₃ PO ₄	TST062019-02A-5-5A	470	41.9
	5 M NaCl	TST062019-02A-3-5A	4.67	0.416
Tube set	WFI	TST062019-03A-6-5A	694	109
	0.5 N NaOH	TST062019-03A-4-5A	816	131
	0.1 M H ₃ PO ₄	TST062019-03A-5-5A	780	122
	5 M NaCl	TST062019-03A-3-5A	7.04	1.14

Table 26. TOC system suitability results

Standard description	Parameter/specification	Result	Conclusion
Benzoquinone and sucrose standards	85 - 115% recovery of benzoquinone relative to sucrose	92.0%	Meets specification
Calibration standards	R2 ≥ 0.995	1.00	Meets specification
Check standards	CV ≤ 5%	0.55 - 1.5%	Meets specification
	85 - 115% recovery	101 - 105%	Meets specification

Table 27. pH results for 30-minute sample extracts

Sample description	Extraction solvent	Chemic sample ID	Result
Method control	WFI	MC-18-6	6.9
	0.1 M H ₃ PO ₄	MC-17-6	1.7
	0.5 N NaOH	MC-16-6	13.3
	5 M NaCl	MC-15-6	6.7
Cassette assembly	WFI	TST062019-02C-6-6	9.7
	0.1 M H ₃ PO ₄	TST062019-02C-5-6	1.7
	0.5 N NaOH	TST062019-02C-4-6	13.3
	5 M NaCl	TST062019-02C-3-6	8.6
Tube set	WFI	TST062019-03C-6-6	7.5
	0.1 M H ₃ PO ₄	TST062019-03C-5-6	1.7
	0.5 N NaOH	TST062019-03C-4-6	13.4
	5 M NaCl	TST062019-03C-3-6	6.6

Table 28. pH results for 1-day sample extracts

Sample description	Extraction solvent	Chemic Sample ID	Result
Method control	WFI	MC-12-6	6.9
	0.1 M H ₃ PO ₄	MC-11-6	1.7
	0.5 N NaOH	MC-10-6	13.3
	5 M NaCl	MC-9-6	6.6
Cassette assembly	WFI	TST062019-02B-6-6	10.2
	0.1 M H ₃ PO ₄	TST062019-02B-5-6	1.8
	0.5 N NaOH	TST062019-02B-4-6	13.3
	5 M NaCl	TST062019-02B-3-6	9.2
Tube set	WFI	TST062019-03B-6-6	6.2
	0.1 M H ₃ PO ₄	TST062019-03B-5-6	1.7
	0.5 N NaOH	TST062019-03B-4-6	13.3
	5 M NaCl	TST062019-03B-3-6	6.2

Table 29. pH results for 21-day sample extracts

Sample description	Extraction solvent	Chemic Sample ID	Result
Method control	WFI	MC-6-6	6.2
	0.1 M H ₃ PO ₄	MC-5-6	1.7
	0.5 N NaOH	MC-4-6	13.3
	5 M NaCl	MC-3-6	6.1
Cassette assembly	WFI	TST062019-02A-6-6	9.9
	0.1 M H ₃ PO ₄	TST062019-02A-5-6	1.8
	0.5 N NaOH	TST062019-02A-4-6	13.3
	5 M NaCl	TST062019-02A-3-6	8.9
Tube set	WFI	TST062019-03A-6-6	4.0
	0.1 M H ₃ PO ₄	TST062019-03A-5-6	1.7
	0.5 N NaOH	TST062019-03A-4-6	13.3
	5 M NaCl	TST062019-03A-3-6	3.5

Table 30. NVR results for 30-minute sample extracts

Sample description	Extraction solvent	Chemic sample ID	Result	
			µg/mL	µg/cm ²
Method control	WFI	MC-18-7	NA	NA
	50% EtOH	MC-13-7	NA	NA
Cassette assembly	WFI	TST062019-02C-6-7	151	13.5
	50% EtOH	TST062019-02C-1-7	809	72.2
Tube set	WFI	TST062019-03C-6-7	< LOQ	< LOQ
	50% EtOH	TST062019-03C-1-7	< LOQ	< LOQ

Table 31. NVR results for 1-day sample extracts

Sample description	Extraction solvent	Chemic sample ID	Result	
			µg/mL	µg/cm ²
Method control	WFI	MC-12-7	NA	NA
	50% EtOH	MC-7-7	NA	NA
Cassette assembly	WFI	TST062019-02B-6-7	494	44.1
	50% EtOH	TST062019-02B-1-7	966	86.2
Tube set	WFI	TST062019-03B-6-7	< LOQ	< LOQ
	50% EtOH	TST062019-03B-1-7	37.5	6.20

Table 32. NVR results for 21-day sample extracts

Sample description	Extraction solvent	Chemic sample ID	Result	
			µg/mL	µg/cm ²
Method control	WFI	MC-6-7	NA	NA
	50% EtOH	MC-1-7	NA	NA
Cassette assembly	WFI	TST062019-02A-6-7	1.32E+03	118
	50% EtOH	TST062019-02A-1-7	1.88E+03	168
Tube set	WFI	TST062019-03A-6-7	< LOQ	< LOQ
	50% EtOH	TST062019-03A-1-7	75.8	8.28

5.3 Acceptance criteria

The extractables testing is compliant when the study has reached its 21-day conclusion. Information gathered will be presented in a report format and reviewed to ensure study protocols were followed. Failure to follow protocols as written will require a deviation to be written in order to justify the results of the extractables testing is still valid.

- Operators must follow approved protocols
- All other test components must perform their function as described in the protocol
- Instrument control test results must be valid

5.4 Endotoxin Test

TangenX® SIUS® Gamma TFF Devices produced by Repligen are flushed, packaged, stored in 0.2 M sodium hydroxide, and gamma irradiated prior to shipment. The careful preparation of these devices allows them to be used in a biopharmaceutical process following a brief buffer equilibration step, no additional sanitization of the cassette is required. The following study was conducted as part of the initial shelf life testing at T₀ to verify that TangenX® SIUS® Gamma TFF Devices do not contain endotoxin that could potentially contaminate a process stream ([Figure 16](#), [Figure 17](#)). This study quantifies the amount of endotoxin flushed from a set of six (6) 0.1 m² TangenX® SIUS® Gamma TFF Devices. A specified volume of purified water was used for the flush and then evaluated for endotoxin count by an approved contract lab using the following methods.

Figure 16. General Procedure for Bacterial endotoxin test

GENERAL PROCEDURE: Two (2) lots of liquid samples, RD903801-3 and RD908704-6, were assayed individually, in duplicate, at the neat concentration. RD903801-3 was also diluted and assayed at the 1:2 and 1:4 dilutions. Standard curves of endotoxin were prepared in duplicate to a lysate sensitivity of 0.06 EU/mL. Positive product controls (PPC) were prepared containing 0.1 mL of the test article and endotoxin at twice the indicated sensitivity of the lysate. Water for Bacterial Endotoxins Test (BET) served as the negative control. Lysate (0.1 mL) was added to 0.1 mL of SIUS Gamma Cassette Shelf Life Sample in each tube. All tubes were incubated in a 37 ± 1°C heat block for 60 ± 2 minutes. After incubation all tubes were examined for agglutination. The study and its design employed methodology to minimize uncertainty of measurement and control of bias for data collection and analysis.

Figure 17. References for Bacterial endotoxin test

REFERENCES: The study was conducted based upon the following references: USP 42, NF 37, 2019. <85> Bacterial Endotoxins Test. USP, current revision, <161> Medical Devices-Bacterial Endotoxin and Pyrogen Tests.

ISO/IEC 17025, 2017, General Requirements for the Competence of Testing and Calibration Laboratories.

One device format with two different membrane chemistries was chosen for this study, i.e., 0.1 m² TangenX® SIUS® Gamma PD TFF Devices with 10 kD ProStream (n = 3) and 10 kD HyStream (n = 3) membranes. The 0.1 m² TangenX® SIUS® Gamma PD TFF Device was chosen as it accurately represents the construction of the entire product line, including surface areas up to 5 m². The two membrane types represent the entire TangenX® SIUS® Gamma TFF Device product portfolio manufactured by Repligen. Devices were manufactured and evaluated in triplicate; each device was prepared using current SOPs and reflected the standard cassette manufacturing process at Repligen. The procedure used for this endotoxin study is found in the approved study protocol TX1001-POQ-164. Acceptance criteria for bioburden and endotoxin testing are shown in [Table 33](#).

The first device in the series of three cassettes was installed the cassette in the cassette holder, then the catalog number and serial number of first cassette was recorded. The device was connected to a purified water outlet source and the retentate and permeate tubing were directed to a sterile 2 L media bottle. The device was flushed with purified water through the retentate into the vessel and collect approximately 0.5 L of the volume with the permeate valve closed. Flushing continued opening the permeate valve while closing the retentate valve 90% of the way collecting 1 L of water through the filtrate. Once approximately 1.5 L of purified water was flushed through the device, a 50 mL pipette was used to transfer the contents to sample vials. The samples were packaged and shipped to a contract lab for endotoxin testing. The samples were analyzed, and the results reported in [Table 34](#) below. The results of the endotoxin count study show that the level of endotoxin was below the detection limit and below acceptable limits when compared to industry standards.

Table 33. Acceptance criteria

Type	Specification limit
Endotoxin	Result < 0.25 EU/mL

Flush samples from each set of cassettes (sampled in triplicate) were pooled together and analyzed for endotoxin (LAL) following the approved study method. The first set of cassette flush samples were shown to contain 0.06 EU/mL of endotoxin and therefore met the acceptance criteria for endotoxin. The second set of cassette flush samples endotoxin count was below the detectable limit of 0.06 EU/mL and also met the acceptance criteria.

Table 34. Results of bioburden and endotoxin count study

Sample ID	Endotoxin
RD903801-3	0.06 EU/mL
RD903804-6	< 0.06 EU/mL

5.5 Sterility

The VDmax25 method 11137: 2006 was used to validate sterility of the TangenX® SIUS® Gamma TFF product line. This method determines the lowest sterilization dose necessary for the determined bioburden population. Sterility testing was carried out by qualified microbiological experts to verify the effectiveness of a sterilization of the wetted fluid path and to validate removal of microorganisms from the product. Sterility testing was performed to confirm requirements for sterility following exposure to gamma irradiation at 25 – 40 kGy. Furthermore, ANSI/AAMI/ISO 11137-1: 2006 and –2: 2006 address the issue of validation and Quarterly Dose Audits for product validated using the VDmax25 method. Once the sterilization dose was established, periodic audits will be performed at a defined and documented frequency. The audits are performed to determine the continued validity of the sterilization dose. The audit will be performed at three-month intervals to detect any changes in the bioburden that could require an augmentation in the sterilization dose.

ANSI/AAMI/ISO 11137: 2006 sterilization dose auditing consists of three major steps.

- Dose Setting - Bacteriostasis/Fungistasis (B/F) & Recovery Efficiency (RE)
- Bioburden testing
- Verification dose experiment

Dose Setting

The bacteriostasis fungistasis test was performed with selected microorganisms to demonstrate the presence of substances that inhibit the multiplication of microorganisms. This was done prior to a sterility test to assure that the readings of the sterility test are true. This test determined that the product is not leaching anything in the test media during the sterility test resulting in false negatives. Three irradiated samples were required for the B/F test. A validation of recovery efficiency was performed prior to conducting bioburden testing, providing an assessment of the efficiency of the specified extraction technique to remove microorganisms from the cassette. A correction factor was derived based on the recovery efficiency and extraction efficiency was determined by using inoculation recovery. Five irradiated samples were required for this method. This was a one-time test for a product unless a change is to be made in materials, supplier, product configuration, or other factors that may impact bioburden or dose absorption.

Bioburden Testing

The bioburden testing is the process of determining the population of viable microorganisms on a given sample (product). In this step of the dose audit, 10 samples are taken from a production batch (lot) to determine bioburden count, also known as the number of Colony Forming Units (CFU's). The results are then used for comparison with bioburden counts that were determined at the time of the initial validation. If for any reason the bioburden count is significantly higher than the initial bioburden, passing a sterilization dose audit may be unlikely. It is also recommended that a gram stain be performed at the time of the bioburden testing. This performance is helpful in identifying if the microorganisms have changed in type as well as in number.

Verification Dose Experiment

The verification dose experiment was performed to determine whether or not a change in the sterilization dose was needed. The verification dose experiment was performed at the dose determined at the time of validation. The verification dose audits were performed as follows:

- Randomly select 20 samples from a production batch prior to the sterilization phase of production
- Ten of these samples are used for bioburden testing. The bioburden testing of these samples were used for trending purposes only
- The remaining 10 samples were then used for the verification dose experiment. The samples were irradiated at the verification dose established at the time of initial validation or the verification dose from the last sterilization dose audit
- The sterility testing was then performed on the irradiated samples to determine if viable microorganisms were still present

Acceptance Criteria

If after the completion of the sterility test, one or no positive sterility samples are obtained, the original sterilization dose is acceptable and no action is required. The positive sterility tests are sterility test samples, which exhibit detectable microbial growth after incubation. If after completion of the sterility test two or more positive sterility tests are obtained, the original sterilization dose is not acceptable and further action is required.

A full report for the VDmax protocol 21-061-TT is available upon request and provides additional details of the sterility validation for the SIUS Gamma cassette. A summary of the results follow in tables 35 – 37 below.

Table 35. Bacteriostasis/Fungistasis (B/F)

Bacteriostasis/Fungistasis (B/F) Testing Summary	
Lot Tested:	20023159
Delivered Dose Range (kGy):	27.91 – to 31.88
Certificate of Processing RRID#	48771
Laboratory Test Report #:	M21083085

No bacteriostasis or fungistasis was observed from the product under the conditions of the test.

Table 36. Recovery Efficiency (RE)

Bioburden Recovery Efficiency (RE) Testing Summary	
Lot Tested:	20023159
Delivered Dose Range (kGy):	27.91 – to 31.88
Recovery Efficiency (%):	152
Correction Factor:	1.0
Certificate of Processing RRID#	48771
Laboratory Test Report #:	R21083084

Table 37. Bioburden Determination Summary

Bacteriostasis/Fungistasis (B/F) Testing Summary	
Lot(s) Tested:	20023159, 20034247, & 20034246
Average Bioburden (CFU):	<4.0
Verification Dose (kGy):	6.1 +/- 10%
Laboratory Test Report #:	B21092072, B21101247-1, & B21101247-2

Table 38. Test of Sterility Summary

Bacteriostasis/Fungistasis (B/F) Testing Summary	
Lot Tested:	20034246
Verification (Testing) Dose kGy:	6.1 +/-10%
Delivered Dose Range (kGy):	5.63 – 6.52
Certificate of Processing RRID#	62601
Laboratory Test Report #:	S21111886

Conclusion

The fluid path of the single use system has been validated following ANSI/AAMI/ISO 11137 guidelines for Vdmax25 to provide a minimum Sterility Assurance Level (SAL) of 10^{-6} for an established irradiation dose. Sterility testing was carried out by qualified microbiological experts to verify the effectiveness of sterilization within the wetted fluid path and to validate removal of microorganisms. A minimum dose of 25 kGy identified for routine sterilization confirmed a sterility assurance level of 10^{-6} was achieved for the TangenX® SIUS® Gamma TFF Cassette product family. Quarterly dose audit testing will continue to be conducted on samples and be irradiated at the sterility testing verification dose.

5.6 BSE free materials

Raw materials used in the manufacture of these products have been accepted for use in accordance with standard operating procedures and meet all incoming release criteria. Repligen certifies that the components used in the production of both membranes and filtration cassettes are BSE free.

The raw materials used in the manufacture of Repligen TangenX® membrane and filtration cassettes do contain traces of animal derived material. Process stabilizers required for the production of several of the polymer-based materials are made using stearic acid. This originates from tallow, a rendered form of beef lard.

However, risk is minimized using this tallow-based stabilizer. Tallow derivatives for industrial, cosmetic, or pharmaceutical uses are considered safe with regard to the risk of contracting TSE/BSE when certain inactivation conditions are met. The reasons are as follows:

- The beef tallow used is TSE/BSE free, as the beef tallow is supplied together with a certificate from the authorities responsible, which states that the tallow originates from healthy animals (ante and postmortem).
- The processing conditions meet the requirements of the “Note for Guidance on Minimizing the Risk of Transmitting Animal Spongiform Encephalopathy Agents via Human and Veterinary Medicinal Products” EMEA/410/01 Rev. 3, effective July 1, 2011.
- The above document(s) define an inactivation method and a hydrolysis process of at least 200°C under an approximate pressure for 20 minutes. These conditions are far exceeded in the production of stabilizer as the tallow is hydrolyzed at about 230°C under 30 bars for at least six (6) hours.
- The stearic acid does not come from high risk countries.

5.7 Residual solvents

Impurities related to residual solvents are specified under ICH Topic Q3C (R4) Impurities: Guideline for Residual Solvents and is outlines acceptable amounts for residual solvents in pharmaceuticals for the safety of the patient. The guideline recommends use of less toxic solvents and describes levels considered to be toxicologically acceptable for some residual solvents.

Residual solvents in pharmaceuticals are defined as organic volatile chemicals that are used or produced in the manufacture of drug substances or excipients, or in the preparation of drug products. The solvents are not completely removed by practical manufacturing techniques. Since there is no therapeutic benefit from residual solvents, residual solvents should be removed to the extent possible to meet product specifications, good manufacturing practices, or other quality-based requirements. Drug products should contain no higher levels of residual solvents than can be supported by safety data.

It is only necessary to test for solvents that are used or produced in the manufacture or purification of drug substances, excipients, or drug product. Although manufacturers may choose to test the drug product, a cumulative method may be used to calculate the residual solvent levels in the drug

product from the levels in the ingredients used to produce the drug product. If the calculation results in a level equal to or below that recommended in this guideline, no testing of the drug product for residual solvents need be considered.

Results from the BPOG extractables study were used to determine residual solvent levels in the TangenX® SIUS® Gamma TFF Device. Both HPLC/MS and GC/MS data detected residual quantities of N-methyl pyrrolidone used in the manufacture of the membrane. The highest levels were detected using the HPLC method after 21 days of extraction and presented below in Table 39.

Table 39. Results of residual solvents: HPLC-MS

	Cassette [‡]	Tubing [‡]
Solvent detected	1-methyl-2-pyrrolidinone	1-methyl-2-pyrrolidinone
Highest level detected	16 ug/cm ²	3 ug/cm ²
	160 mg/m ²	30 mg/m ²
Process loading	200L/m ²	200 L/m ²
NMP max concentration	0.8 mg/L	0.15 mg/L
	0.8 ppm	0.15 ppm
ICH guidelines for NMP	< 530 ppm	< 530 ppm

[‡] Highest value reported, 21-day time point

N-methyl pyrrolidone (NMP) is a Class 2 solvent and should be limited to 530 ppm in pharmaceutical products. A typical process loading of 200 L/m² would result in a maximum concentration of approximately 1 ppm in the batch of drug processed assuming the NMP is not concentrated, diluted, or removed throughout the purification process. This level is below the <530 ppm limit established in the ICH guidelines.

6. Qualification

An IQ and OQ were performed for each piece of critical equipment utilized in the production of the membrane and device assembly. Initial qualifications were performed when the new process and equipment that was unique in application were introduced following the procedure PAQ-SOP-1087. Repeat or supplementary qualification activities are performed when a significant change in process, equipment or system is introduced.

6.1 Installation Qualification (IQ)

Verification that the item qualified was installed correctly. The following criteria was considered in each IQ:

- Equipment design features (i.e. materials of construction, clean ability, etc.)
- Installation conditions (wiring, utilities, functionality, etc.)
- Calibration, preventative maintenance, cleaning schedules
- Safety features
- Supplier documentation, prints, drawings and manuals
- Software documentation
- Spare parts list and inventory
- Environmental conditions (such as clean room requirements, temperature, humidity)

6.2 Operation Qualification (OQ)

Parameters were challenged to assure that outputs met all defined requirements under all anticipated conditions of operations. To establish process control limits, critical parameters and or product characteristics were challenged. These control limits were established and documented to

determine the robustness of the process through the spectrum of potential ranges. The following criteria were considered in each OQ:

- Process control limits (time, temperature, pressure, line-speed, setup conditions, etc.)
- Documented procedures and work instructions
- Software parameters
- Raw material specifications
- Process operating procedures
- Material handling requirements
- Potential failure modes, action levels and worst-case conditions (failure mode and effects analysis, fault tree analysis)

Qualifications were performed with a risk based approach utilizing PAQ-SOP-1023 all potential risks associated with the processes, system, analytical method, and/or equipment that were addressed with appropriate risk level and mitigation. Any risk that is identified as major or critical was challenged during qualification and/or validation activities.

6.3 Responsibilities

System Owner: Ensures that the validation parameters, requirements, and the acceptance criteria are properly determined.

Operator/Executor: Ensures protocol is performed as per the approved document and executes the qualification/validation in accordance with the protocol and good documentation practices (GDP).

Technical Lead: Generates draft protocols which are circulated to subject matter experts within the organization for review and approval. Reviews and approves the final validation report to confirm that the process, system, analytical method, and/or equipment are suitable for its intended use.

Quality Assurance: Reviews and approves the validation protocol and approves the final report to confirm that the protocol was properly executed and that any deviations/discrepancies have been addressed and documented.

7. Manufacturing process validation

The objective of the process validation is the collection and evaluation of data, from the process design stage throughout commercial production, which establishes scientific evidence that a process is capable of consistently delivering quality product. This involves a series of activities taking place over the manufacturing process. Validation of the membrane manufacturing process was carried out independently as the membrane is used throughout several different cassette product lines at Repligen. The TangenX® SIUS® Gamma TFF Device process validation was conducted following the Repligen validation program specified in the procedure PAQ-SOP-1087.

The process validation consists of an evaluation of a defined, documented procedure to consistently deliver an expected result. PQ considerations include:

- Actual product and process parameters and procedures established in OQ
- Acceptability of the product
- Assurance of process capability and control as established in OQ
- Process repeatability, long term process stability

Final reports will summarize the results of an executed qualification and/or validation protocol and document the supported conclusion based on the data obtained. The report will summarize of all data collection and analyzation as specified in the protocol. It will also summarize and discuss all non-conformances, deviations, observations, and data acquired during the execution of the approved protocol for the validation and/or qualification.

7.1 Membrane process validation

The membrane process validation activities were conducted for the specific process of the flat-sheet membrane manufacturing operation at the Repligen Marlborough facility. The process validation applied to the membrane manufacturing process using equipment specified in the master equipment list I.LIS.022. The validation report R-Tangenx-190902 includes a summary of results for the casting solution preparation, membrane casting procedure, post-treatment, drying, slitting, membrane QC testing procedure and their corresponding forms.

The membrane manufacturing process referenced in this validation report consisted of six major parts. The casting solution preparation required individual components of the membrane be dissolved in a solvent creating a casting solution that will be coated onto a non-woven substrate. The membrane casting process used the casting machine to coat the casting solution and form the membrane as it moved through the machine. The extraction post-treatment system flushed the membrane with purified water and removed residual solvents. The glycerin post-treatment system treated the membrane with a preservative. The membrane drying operation dried the membrane, removing water from the pores. During the validation of the membranes, samples were taken once the membrane rolls were processed according to the membrane manufacturing casting POP-SOP-1068. The membrane was cut into 33-inch sheets and retain samples were collected as described in the procedure POP-SOP-1069.

The casting solution data collected for the first three batches of membrane processed during the membrane manufacturing process validation were HyStream 100 kD (XP100) membrane. Each of these membranes met the critical parameters specified in the approved procedure POP-SOP-1027. [Figure 18](#) summarizes the critical conditions captured for the casting solution used for each lot of the XP100 membranes cast. The table is formatted in a comparable manner to the casting solution specification guide IF.CFG-POP.1027.

The casting solution data collected for the next three batches of ProStream 10 kD (PP010) membrane processed during the membrane manufacturing process validation met the critical parameters specified in the approved procedure POP-SOP-1027. [Figure 18](#) summarizes the critical conditions captured for the casting solution used for each lot of the PP010 membranes cast.

Membranes produced as part of the process validation were tested following a validated test method as instructed in the procedure POP-SOP-1030. Membranes were sampled as described in the procedure POP-SOP-1030 and tested using 44.5 mm stirred cells. Membranes were tested and compared to release criteria for the following:

- Normalized Water Permeability (NWP)
- Percent deviation of NWP
- Passing solute flux
- Passing solute % rejection
- Retaining solute flux
- Retaining solute % rejection

The test data collected for the membrane processed during the membrane manufacturing process validation was used to confirm the process validation was successful. [Figure 18](#) summarizes and compares the test data generated for each lot of membranes produced. The table is formatted in a comparable manner to the casting solution specification guide IF.CFG-POP.1030. The first row of the table identifies the contents listed in the columns below, release specifications for the HyStream 100 kD membrane are shown in red colored text on the second row of the table. Release specifications for the ProStream 10 kD membrane are shown in red colored text on the sixth row of the table below.

Figure 18. Membrane validation: Data summary

LOT NUMBER	MEMBRANE TYPE	MEMBRA MWCO	PART NUMBER	CAST LENGTH (lin foot)	AVERAGE NWP		PASSING SOLUTE		RETAINING SOLUTE	
					LMH / psi	PERCENT DEVIATION	FLUX	REJECTION	FLUX	REJECTION
					50-140	≤15	305-550	≤20	50-90	≥90
F19220A	Hystream	100	XP100-S2	393.0	55.0	4.7	449.2	3.2	54.8	96.8
F19220B	Hystream	100	XP100-S2	430.0	52.1	3.9	432.5	3.1	58.9	97.1
F19220C	Hystream	100	XP100-S2	404.0	53.8	5.4	470.3	3.9	57.8	96.9
					9.5-22	≤15	140-250	30-60	75-110	≥85
F19220D	Prostream	10	PP010-S2	270.0	14.8	4.3	142.3	34.6	81.2	90.4
F19220E	Prostream	10	PP010-S2	341.0	13.3	9.7	170.4	39.4	79.9	89.7
F19220F	Prostream	10	PP010-S2	312.0	11.8	9.8	163.3	41.4	81.6	91.1

The membrane lot number shown in the first row of the table corresponds with the data set generated for each membrane during testing. The HyStream 100 kD membrane met the critical parameters specified in the approved procedure POP-SOP-1030 and specification guide IF.MSG-POP.1030. The observed NWP was at the lower end of the accepted range but is consistent with 100 kD membranes currently produced using the original membrane equipment being replaced. The passing solute flux rate and percent rejection are within the accepted range and ideally fell into the middle of the specification. The retaining solute flux rate and percent rejection were within the accepted range and showed each membrane batch met the specifications for a 100 kD membrane. Each of the ProStream 10 kD membranes met the critical parameters specified. The NWP was within the accepted range and ideally fell into the middle of the specification. The passing solute flux rate and percent rejection were also within the accepted range for a 10 kD membrane. The retaining solute flux rate and percent rejection were within the accepted range and showed each membrane batch met the specification for a 10 kD membrane.

Three consecutive lots of two different membrane types were manufactured as part of the membrane process validation. The validation was considered successful as three lots of each membrane type were in conformance with the defined specification. Two membrane types, HyStream 100 kD and ProStream 10 kD were each validated and were identified to represent the TangenX® membrane product line. Each membrane batch was manufactured in accordance with approved procedures. Each of the membrane lot was shown to meet product specifications following procedure POP-SOP-1030 and found to be within compliance. The membrane validation is complete and the membrane manufacturing process at the Repligen Marlborough site is considered validated.

7.2 TangenX® SIUS® Gamma TFF Device process validation

This section of the document describes the process validation report for the TangenX® SIUS® Gamma TFF Device manufacturing operation at the Repligen Marlborough facility. The validation included approved procedures for cassette assembly, parts washing, corona treatment, assembly, integrity testing, bagging, packaging, and gamma-irradiation with their corresponding forms. The cassette assembly process has acceptance criteria, per IF.SRG-POP.1033 and is a currently validated process that is not changing. The process validation focused on the new portion of the process to build TangenX® SIUS® Gamma TFF Device assemblies. Testing acceptance criteria is specified in [Figure 18](#) of this document.

This summary defines the validation within the Repligen Marlborough facility for the TangenX® SIUS® Gamma TFF Device manufacturing process. Four batches consisting of six (6) units each were run. The matrix includes two sets of lab-scale cassettes and two sets of process-scale cassettes, representing the full TangenX® SIUS® Gamma TFF Device product line. The membrane type is not specific as the device assembly process is unchanged, however each membrane chemistry was evaluated (ProStream and HyStream); tight and open pore sizes were used (10 kD and 300 kD) to represent the full range. This process validation is per DHF0012 and the data generated shows conformance to the process validation protocol, PV-TANGENX-191101.

Responsibilities for the validation fall upon product engineering to write the report and ensure that the report meets the requirements stated in PAQ-SOP-1087: Repligen Validation process. Engineering is also responsible for ensuring that the validation is performed in compliance with the protocol and with any designated SOPs. Drafting, reviewing, and approving validation protocols and/or reports and all associated data also falls on the engineering group. Manufacturing supports validation activities, generating and providing supporting data. Manufacturing also ensures access to necessary raw materials, utilities, and resources for execution. Quality is responsible for reviewing and approving validation protocols and/or reports and all associated data. Quality is also responsible for maintaining records of executed and completed validation protocols and/or reports and all supporting documentation.

Prerequisites include evidence of all raw materials used in the validation were approved and released by quality assurance. All specifications must be written and approved. All the equipment used during the process validation must be qualified. The critical equipment must be calibrated and recorded in their corresponding logbooks. Protocols, process parameters to be controlled/calibrated can be referenced in the validation report R-TANGENX-200103.

The individual procedures were combined and executed as one validation group where four consecutive serialized batches of cassettes were manufactured. Each of the cassettes were individually tested according to the approved Cassette QC Testing Procedure and QC Release specifications specified in POP-SOP-1033. Each cassette was tested in the cassette QC test area for liquid volume flow rate and air mass flow rate. Completed assemblies were tested for leaks and a final visual inspection per the assembly procedure POP-SOP-1058.

Following the validation, Quality Assurance conducted a review of the test data, verifying the adherence to set specifications. Quality Assurance was responsible for the final review of the executed validation procedures and test results. The test results for each device are found below in Table 40.

Table 40. Device validation: Data summary

Catalog #	Membrane chemistry	Area (m ²)	MWCO (kD)	Serial #	Qty tested	Qty passed	Test yield
XP100C01L	HyStream	0.1	100	29325049 - 29325054	6	6	100%
XP100F05L	HyStream	0.5	100	29325001 - 29325006	6	6	100%
PP010C01L	ProStream	0.1	10	29325037 - 29325042	6	6	100%
PP010F05L	ProStream	0.5	10	29325043 - 29325048	6	6	100%

All devices passed testing per criteria per [Figure 19](#) and final inspection defined in the procedure POP-SOP-10S8. All validation documentation was successfully completed, per the validation protocol PV-TANGENX-191101. The TangenX® SIUS® Gamma TFF Device assembly process was considered validated and released for production usage with the completion of the Design History File, DHF0012 requirements.

8. Release testing

8.1 Analytical method validation

Selective analytical methods for the quantitative evaluation of membrane and membrane-based products are necessary for the QC release of these devices. Analytical method qualification includes all the procedures that demonstrate that a particular method used for quantitative measurement of samples in a given matrix is reliable and reproducible for the intended use. The fundamental parameters for qualification include specificity, linearity, accuracy, precision, and robustness.

Method validation involved documenting that the performance characteristics of the methods were suitable and reliable for the intended applications. The acceptability of analytical data corresponds directly to the criteria used to qualify the method. Specific, detailed descriptions of the analytical methods were written in the form of a standard operating procedure for both membrane and cassette QC testing. Each step in these methods were investigated to determine the extent to which environmental, matrix, or procedural variables can affect the estimation of material in the matrix.

In the case of sensitive quantitative procedures such as these, appropriate steps were taken to ensure the lack of matrix effects throughout the application of the method. These analytical methods were validated for the intended use of membrane characterization and cassette release. All experiments used to make claims or draw conclusions about the validity of the method are presented in a method qualification report. In process test methods include both membrane and cassette QC methods.

8.2 Membrane QC method validation

The purpose of the membrane QC testing method validation was to validate the membrane QC testing procedure. This procedure refers to ultrafiltration and microfiltration membranes manufactured by Repligen. Membranes are initially manufactured and then tested for performance prior to being incorporated into a cassette product. A report summarizing the verification of specificity, linearity, accuracy, precision, and robustness of the membrane QC test procedure was written. Minimum requirements including acceptance specifications for the methods were set during the method development and validation cycle. The acceptance criteria are found in each of the data sheets found in the body of the report.

The principles followed for the membrane QC method validation were based on cGMP guidelines and helped Repligen ensure the test method was acceptable for use. The membrane QC procedure is used to verify each membrane's water permeability and protein rejection. This information is then used to accept or reject the membranes manufactured at Repligen. At the conclusion of the

validation, it was proven that membrane QC method meets requirements set by Repligen for specificity, linearity, accuracy, precision, and robustness. Minimum requirements, which were essentially acceptance specifications for the methods, were met during the method development and validation cycle and the QC membrane test procedure considered validated.

8.3 Cassette QC method validation

The purpose of the cassette QC testing method validation was to validate the cassette QC testing procedure. This procedure refers to ultrafiltration and microfiltration cassettes manufactured by Repligen. The cassettes are initially manufactured and then tested for performance prior to being released as final product. A written report summarizes the verification of specificity, linearity, accuracy, precision, and robustness of the cassette QC test procedure. Minimum requirements including acceptance specifications for the methods, were set during the method development and validation cycle. The acceptance criteria are found in each of the data sheets found in the body of the report. The procedure used for the method validation was described in the validation protocol listed the steps that were followed during the validation.

The principles followed for the validation were based on cGMP guidelines and helped Repligen ensure the cassette QC test method was acceptable for use. The cassette QC procedure was used to verify each cassette's air diffusion and cross flow rate. This information is then used to accept or reject the cassettes manufactured at Repligen. At the conclusion of the validation, it was proven that cassette QC method meets requirements set by Repligen for specificity, linearity, accuracy, precision, and robustness. Minimum requirements including acceptance specifications for the methods were met during the method development and validation cycle and validation cycle and the QC membrane test procedure considered validated.

8.4 Release specifications

A complete set of TangenX® SIUS® Gamma PD TFF Device and TangenX® SIUS® Gamma TFF Device release specifications are listed in [Figure 19](#), as taken from document IF.SRG-POP.1033. [Figure 20](#) presents the release specifications for both membrane chemistries, as taken from document IF.MSG-POP.1030.

- Cassette QC Release Specifications: IF.SRG-POP.1033
 - See [Figure 19](#)
- Membrane QC Release Specifications: IF.MSG-POP.1030
 - See [Figure 20](#)

Figure 19. Device QC release specifications

IDENTIFICATION: IF.SRG-POP.1033		FORM STATUS: APPROVED 11 Oct 2019
REVISION: R10	SINGLE-USE CASSETTE QC RELEASE SPECIFICATION GUIDE	

CONFIG ID #	PRESSURE DROP		AIR INTEGRITY		⁽¹¹⁾ USE...		
	PRESSURE PSI	FLOW RATE ⁽²⁾ LITER/MINUTE	FLOW RATE CCM	AIR PRESSURE	GASKET TYPE	TEST STATION	FLOW METER
LOW PRESSURE SCREEN CHANNEL : CHANNEL ID = L							
LP1 / MP1	10 ±0.5	0.040 TO 0.080	≤ 3	SEE NOTE 4	1/32" EPDM	CTS01	FT1
LP2 / MP2		0.080 TO 0.160	≤ 6	SEE NOTE 4	1/32" EPDM	CTS01	FT1
L01/M01/C01		0.40 TO 0.80	≤ 30	SEE NOTE 4	1/16" EPDM	CTS01	FT2
G02		0.80 TO 1.60	≤ 60	SEE NOTE 4	1/16" EPDM	CTS02	FT5
G05 / F05		2.00 TO 4.00	≤ 150	SEE NOTE 4	1/16" EPDM	CTS02	FT5
G15 / F15		6.00 TO 12.00	≤ 450	SEE NOTE 4	1/16" EPDM	CTS02	FT4
G25 / F25	5 ±0.5	5.00 TO 10.00	≤ 750	SEE NOTE 4	1/16" EPDM	CTS02	FT4

EXTRA LOW PRESSURE SCREEN CHANNEL : CHANNEL ID = E							
LP1 / MP1	5 ±0.5	0.06 TO 0.12	≤ 3	SEE NOTE 4	1/32" EPDM	CTS01	FT1
LP2 / MP2		0.12 TO 0.24	≤ 6	SEE NOTE 4	1/32" EPDM	CTS01	FT2
L01/M01/C01		0.60 TO 1.20	≤ 30	SEE NOTE 4	1/16" EPDM	CTS01	FT3
G05 / F05		3.00 TO 6.00	≤ 150	SEE NOTE 4	1/16" EPDM	CTS02	FT4
G15 / F15	2.5 ±0.5	4.50 TO 9.00	≤ 450	SEE NOTE 4	1/16" EPDM	CTS02	FT4
G25 / F25		7.50 TO 15.00	≤ 750	SEE NOTE 4	1/16" EPDM	CTS02	FT4

4) CASSETTE AIR INTEGRITY SET PRESSURES ARE DEFINED BELOW BASED ON MEMBRANE CUT OFF (MWC0). MASS FLOW RATE LIMITS SHOWN IN THE TABLES APPLY AT EACH PRESSURE.

- USE 7.3 psi for 10kD, 30kD, 50kD, 100kD, 300kD

Figure 20. Membrane QC release specifications (10 kD - 300 kD)

		Normalized Water Permeability										Selectivity																
Part Number (4)	MWCO (Daltons)	WATER FLUX (LMH/PSI)	Deviation (%)	Pressure (psi)	1.3kD		15kD		12kD		12.8kD		45kD		67kD		167kD		200kD		0.16um		0.3um		0.5um		0.9um	
					Vitamin B-12 Flux (LMH)	Vitamin B-12 %Rej.	Bacitracin Flux (LMH)	Bacitracin %Rej.	Cytochrome-C Flux (LMH)	Cytochrome-C %Rej.	Flux (LMH)	%Rej.	Flux (LMH)	%Rej.	Flux (LMH)	%Rej.	Flux (LMH)	%Rej.	Flux (LMH)	%Rej.	Flux (LMH)	%Rej.	Flux (LMH)	%Rej.	Flux (LMH)	%Rej.	Flux (LMH)	%Rej.
PPM65	0.65K	0.30-0.60	±25%	50	12-24	25-55	5-14	≥85																				
PP001	1K	0.80-1.50	±15%	50	24-48	≤25	13-24	≥70																				
PPH01	H01	1.30-3.20	±15%	50			20-50	60-80	40-80	≥98%																		
PP003	3K	1.85-3.85	±15%	50			30-60	50-70	42-90	≥95%																		
PP005	5K	2.75-6.00	±15%	50			80-120	≤40%																				
PP010	10K	9.50-22.0	±15%	50																								
PP030	30K	30.0-50.0	±15%	50																								
PP050	50K	45.0-75.0	±15%	50																								
PP100	100K	50.0-140	±15%	10																								
PP300	300K	190-300	±15%	10																								
PPM10	0.1um	750-1500	±15%	10 ⁽¹⁾																								
PPM20	0.2um	1720-3550	±15%	5 ⁽¹⁾																								
PPM45	0.45um	> 2175	±15%	3 ⁽¹⁾																								
PPM65	0.65um	> 2550	±15%	3 ⁽¹⁾																								

8.5 Certificate of conformance

Figure 21 shows an example of the standard Quality Assurance Certificate provided with each TangenX® SIUS® Gamma TFF Device manufactured by Repligen. A specific product part number, serial number, and description will be included on the label attached in the upper left corner of the certificate.

Figure 21. QA Certificate of conformance for TangenX® SIUS® Gamma TFF Device



REPLIGEN
INSPIRING ADVANCES IN BIOPROCESSING

Repligen Corporation
111 Locke Drive
Marlborough, MA 01752
Phone: 508-845-6400
Fax: 508-845-3030

This is to certify that the TangenX® SIUS® Gamma Cassettes as indicated by the affixed label complies with the following descriptions and specifications:

Product Quality – TangenX® SIUS® Gamma Cassettes

This product has been manufactured in a fully validated and documented manufacturing process under an ISO 9001:2015 quality management system.

This product was manufactured and tested according to standard operating procedures and was found to meet all release criteria. This article will perform according to the manufacturer's published specifications when used according to the manufacturer's recommendations.

100% Release Testing

Each membrane lot is inspected prior to incorporation into a cassette. Before assembly, the membrane used in each cassette is tested for flow rate, retention and physical specifications.

Each cassette has been flushed with D.I. water, sanitized with 0.2M NaOH, and individually tested against the following performance specifications:

- Hydraulic performance - a measure of the cross-flow rate at a specified pressure drop.
- Integrity - a measure of the rate of air diffusion through the cassette at a specified pressure differential.

The minimum requirements for each test was set by our Quality Assurance Department.

Each cassette has been gamma irradiated to 25 – 40 kGy and verified following procedure PDP-SOP-1075

Validation

All component materials were shown to meet:

- USP Class VI biological test for plastics.
- USP guidelines: USP 30-NF-75, 2007, <788> for particulate matter in injections.
- Certifications for BSA/TSE free components.

All component materials used in cassettes manufactured by Repligen were tested for USP safety and were shown to be safe according to:

- L929 MEM Elution per USP <87>.
- Class VI per USP <88>.
- Hemolysis – Indirect with Rabbit Blood.

All finished component materials were tested under controlled conditions for extractables following BPOG guidelines.

- 6 Model Solvents
- 21 Day Extraction
- 40°C Extraction Temperature

A representative of population TangenX® SIUS® Cassettes were tested for:

- Endotoxin testing following references the limulus amoebocyte lysate (LAL) test as an end product. Acceptance criteria is specified as < 0.25 EU/ml as determined by the LAL test method.

Sterility

The fluid path of the single use system has been validated following ANSI/AAMI/ISO 11137 guidelines for Vdmax²⁸ to provide a minimum Sterility Assurance Level (SAL) of 10⁻⁶ for an established irradiation dose.

Signature Required:

Reviewed and approved for accuracy and completeness.

Paul Wallace, Director of Quality

Signature and Title



REPLIGEN Marlborough, Massachusetts USA
www.repligen.com/tangenx

TangenX™ SIUS™ PD Gamma Cassette

BATCH # 20012198 ■ GAMMA IRRADIATED ■ SINGLE USE ONLY

USE BY: **06-NOV-2023**

MEMBRANE: **ProStream (Low Binding mPES)**

MWCO: **100 kD**

CHANNEL: **LP Screen Channel**

AREA: **0.1 m² (1.1 ft²)**

SERIAL #

30311212



CATALOG #

PP100C01L

QAD0C017 R3 | Page 1 of 1

repligen.com

9. List of TangenX® Cassette and Device studies

- | | |
|---------------------|---|
| 1. TX1001-POQ-117-R | Protein Binding Study |
| 2. 10827-19-3528 | SIUS® Gamma Cassette & Tubing Assy. Extractables Assessment |
| 3. TX1001-POQ-159-R | SIUS® Gamma Cassette Robustness Study |
| 4. TX1001-POQ-125-R | Membrane QC Testing Method Validation |
| 5. TX1001-POQ-132-R | Cassette QC Testing Method Validation |
| 6. TX1001-POQ-164 | SIUS® Gamma Cassette Shelf Life Study |
| 7. R-TANGENX-190902 | Membrane Validation |
| 8. R-TANGENX-200103 | Process Validation Report - SIUS® Gamma Manufacturing |

10. References

1. Class VI Test per USP <88> Includes: Systemic Injection, Intracutaneous Injection, & 7-Day Muscle Implant.
2. ANSI/AAMI/ISO 11137-1. 2006/(R) 2010 & A1:2013 Sterilization of health care products – Part 1: Requirements for Development, validation, and routine control of a sterilization process for medical devices.
3. ISO/IEC 17025, 2017, General Requirements for the Competence of Testing and Calibration Laboratories.
4. USP 42, NF 37, 2019 <85> Bacterial Endotoxin Test, USP current revision, <161> Medical Devices Bacterial Endotoxin and Pyrogen Tests.
5. BPOG – Best Practices Guide for Evaluating Leachables Risk in Biopharmaceutical Single-Use Systems: 2017; Sexton, Aidan W., et.al.
6. Standardized Extractables Testing Protocol for Single-Use Systems in Biomanufacturing: 2014; Weibing Ding, Gary Madsen, Ekta Mahajan, Seamus O’Connor, Ken Wong.
7. EMA Note for guidance on minimizing the risk of transmitting animal spongiform encephalopathy agents via human and veterinary medicinal products (EMA/410/01 rev.3).
8. ICH Topic Q3C (R4) Impurities: Guideline for Residual Solvents.

Index

No index entries found.